

Organizational Chart 9-1-2011

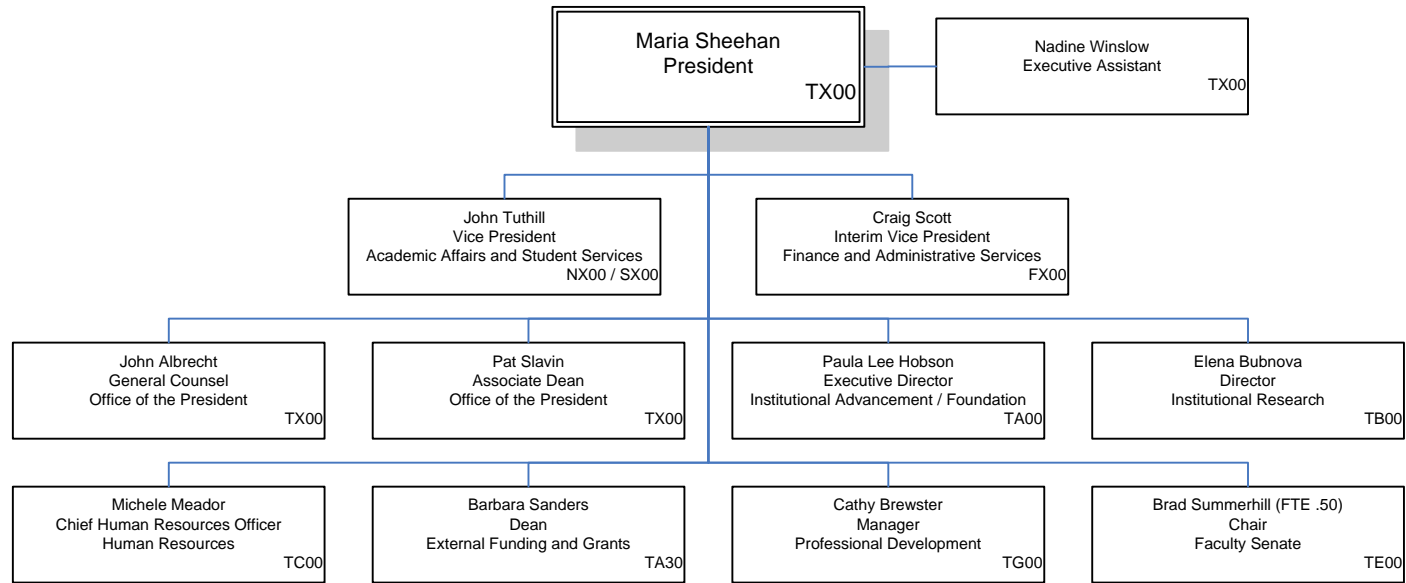

Organizational Chart 9-1-2011

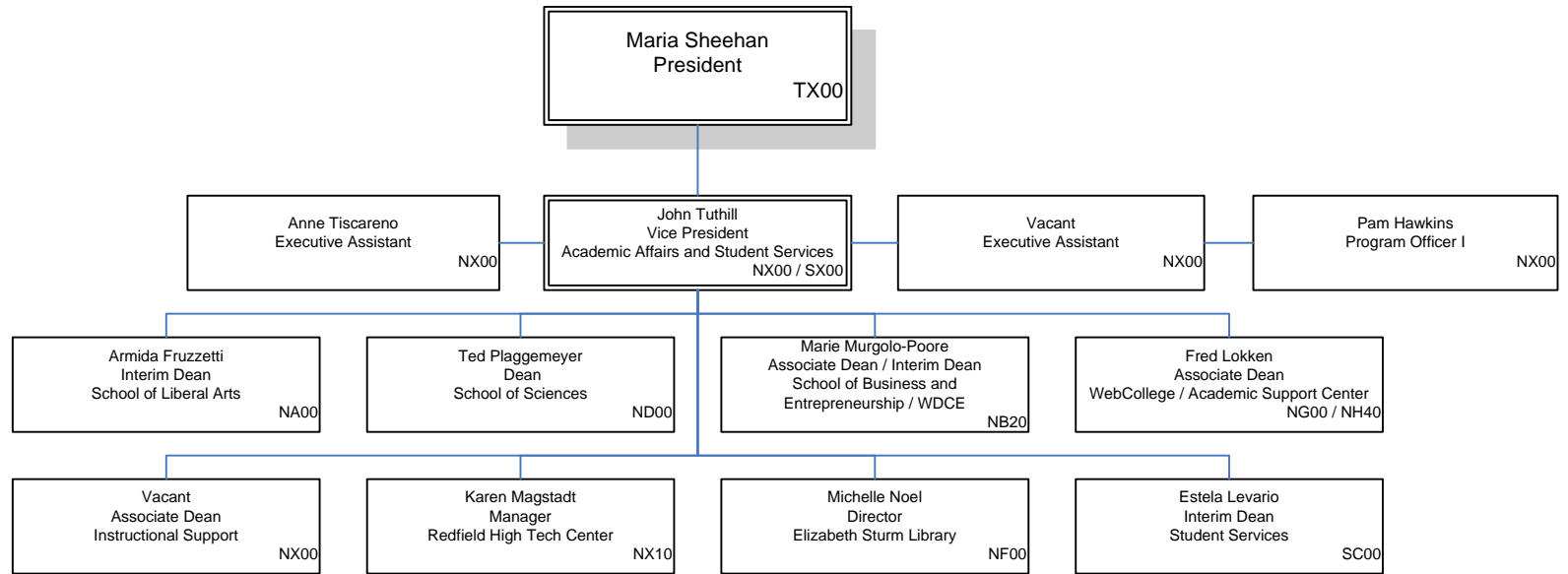

Organizational Chart 9-1-2011

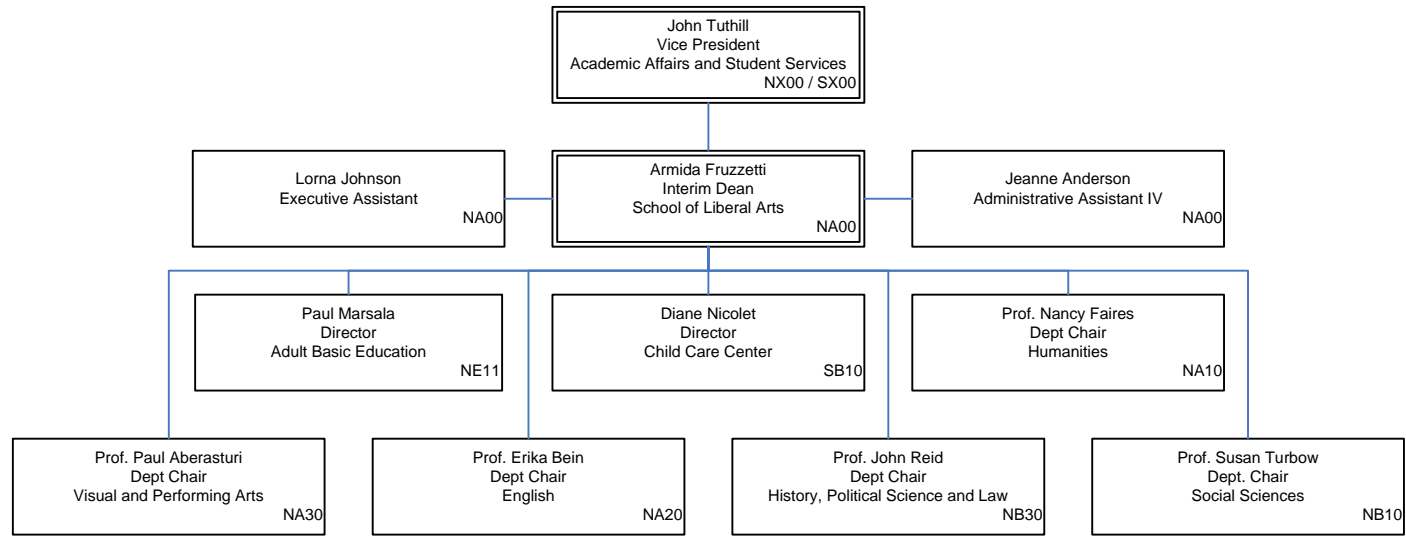

Organizational Chart 9-1-2011

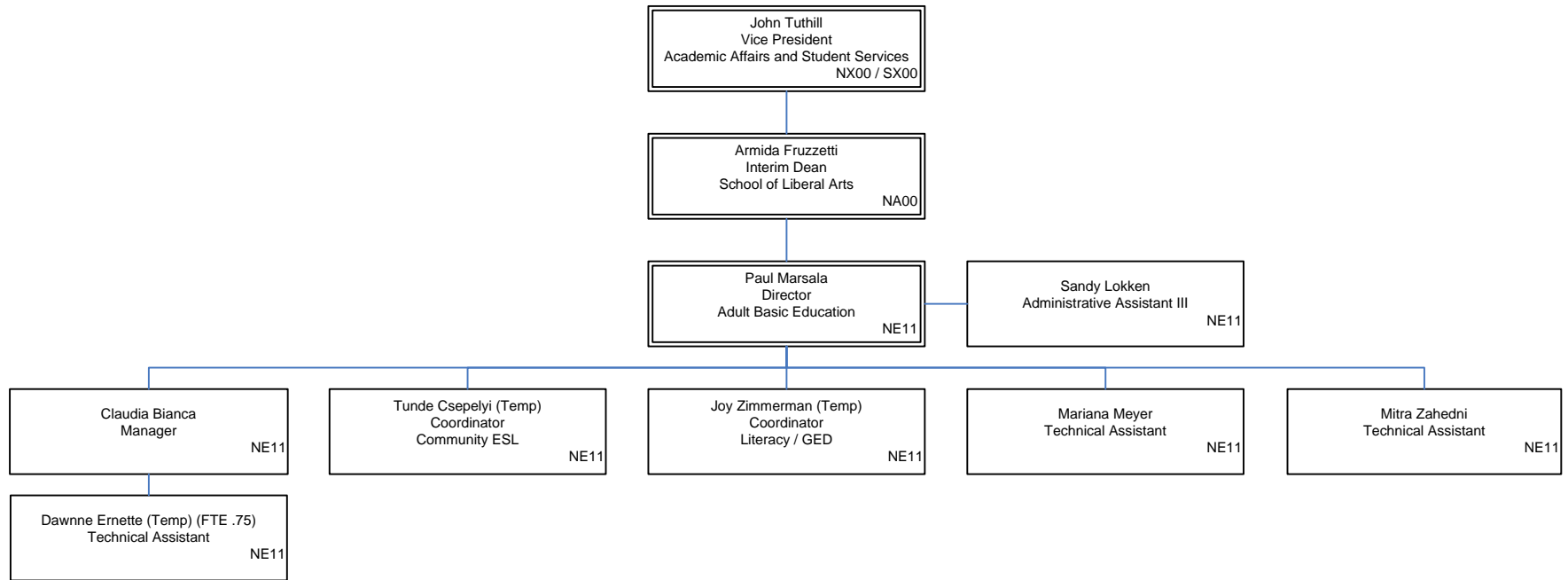

Organizational Chart 9-1-2011

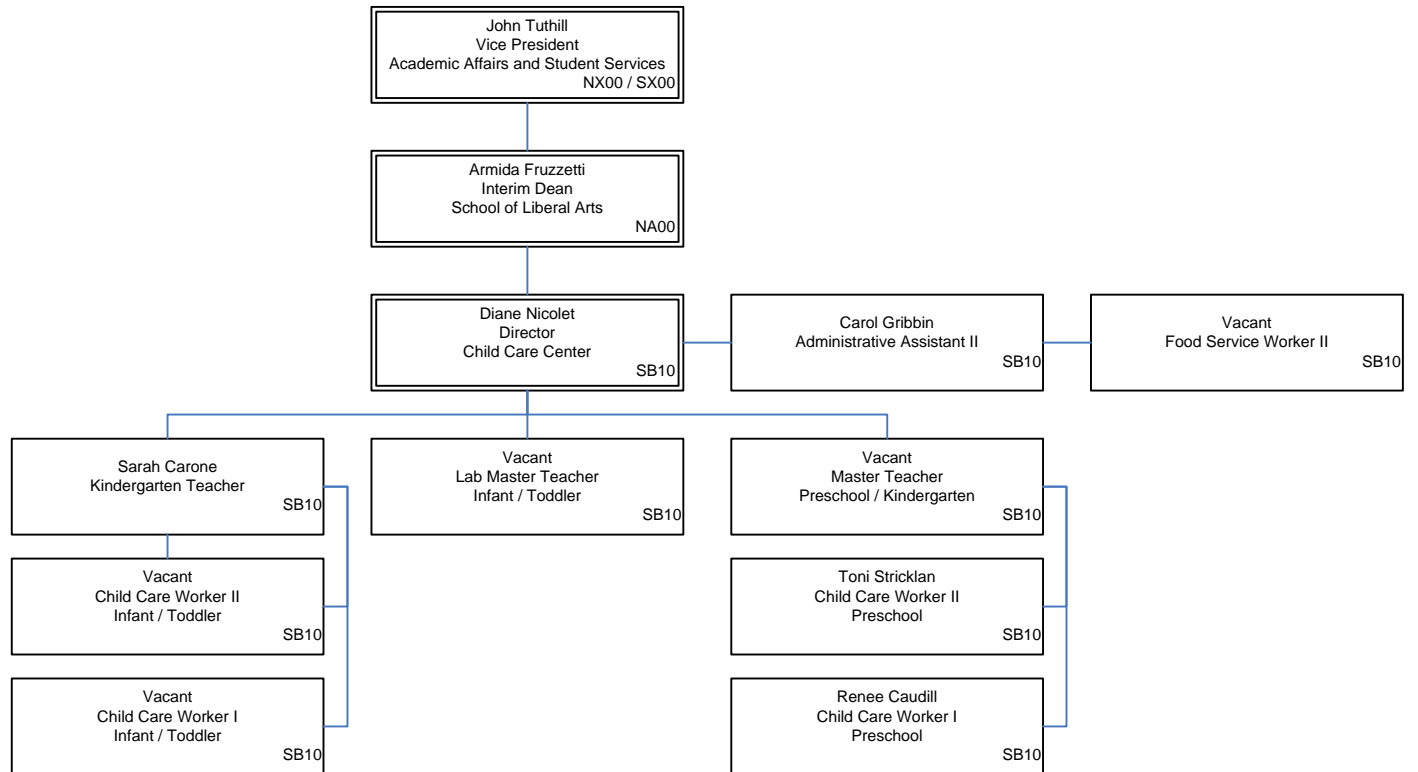

Organizational Chart 9-1-2011

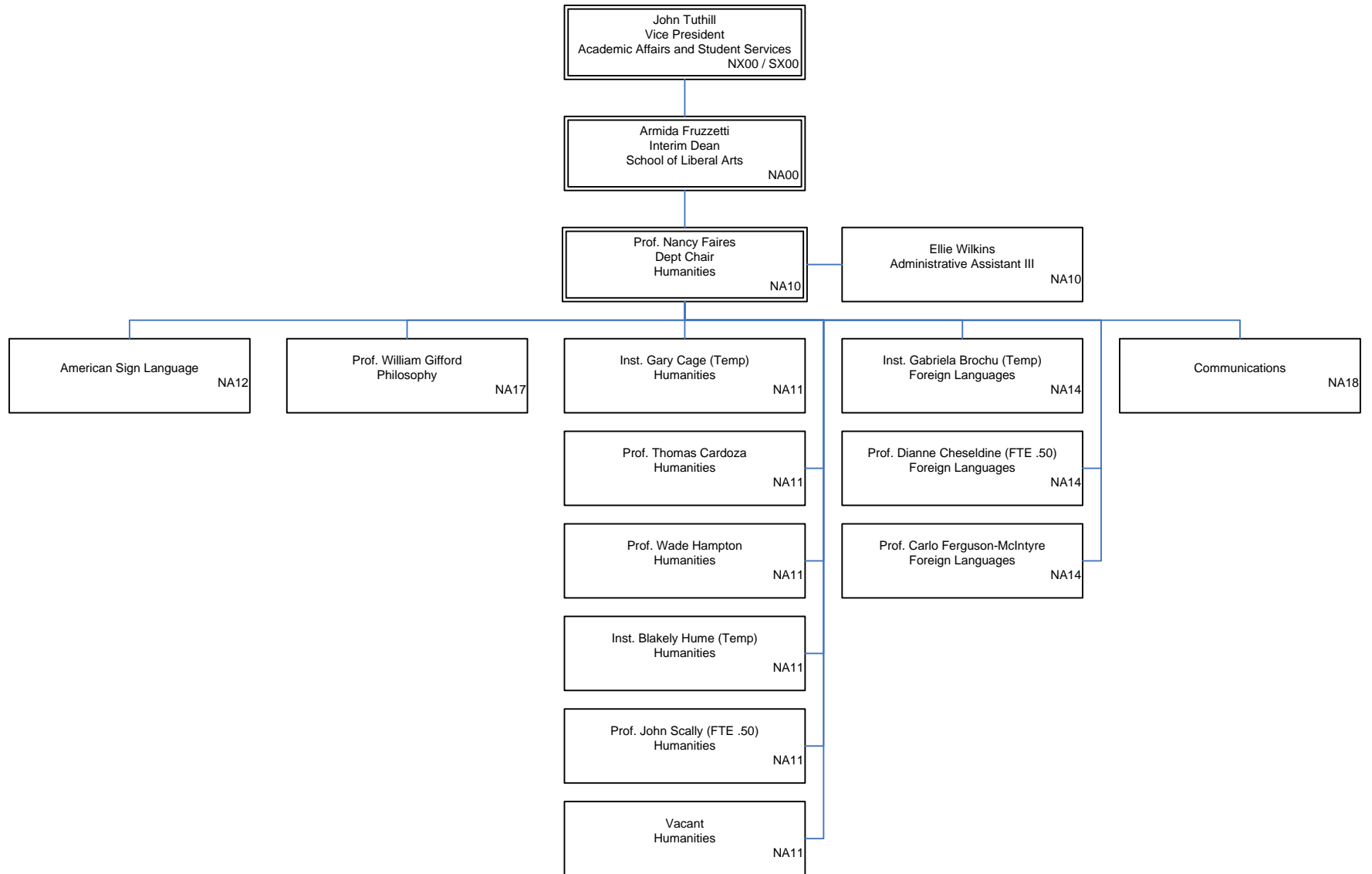

Organizational Chart 9-1-2011

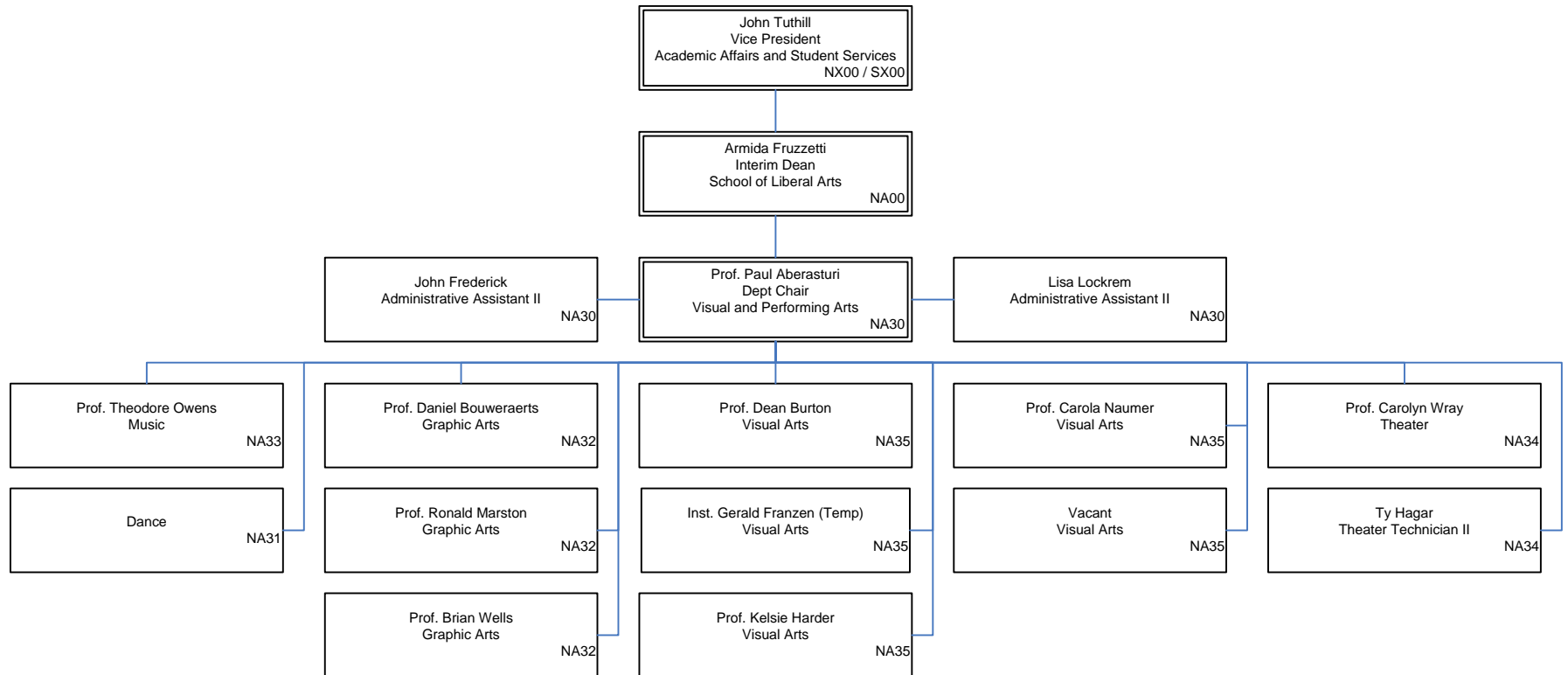

Organizational Chart 9-1-2011

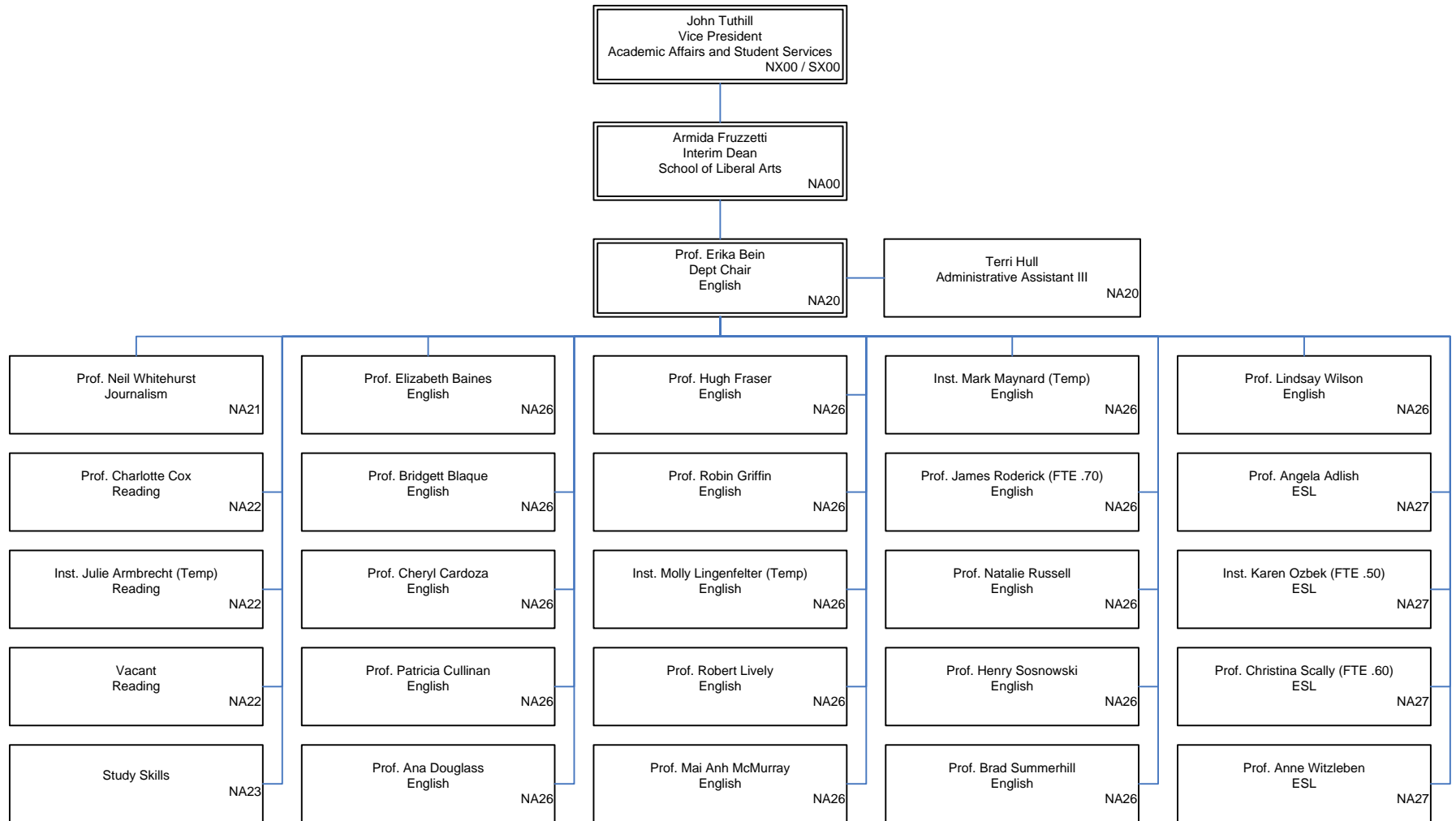

Organizational Chart 9-1-2011

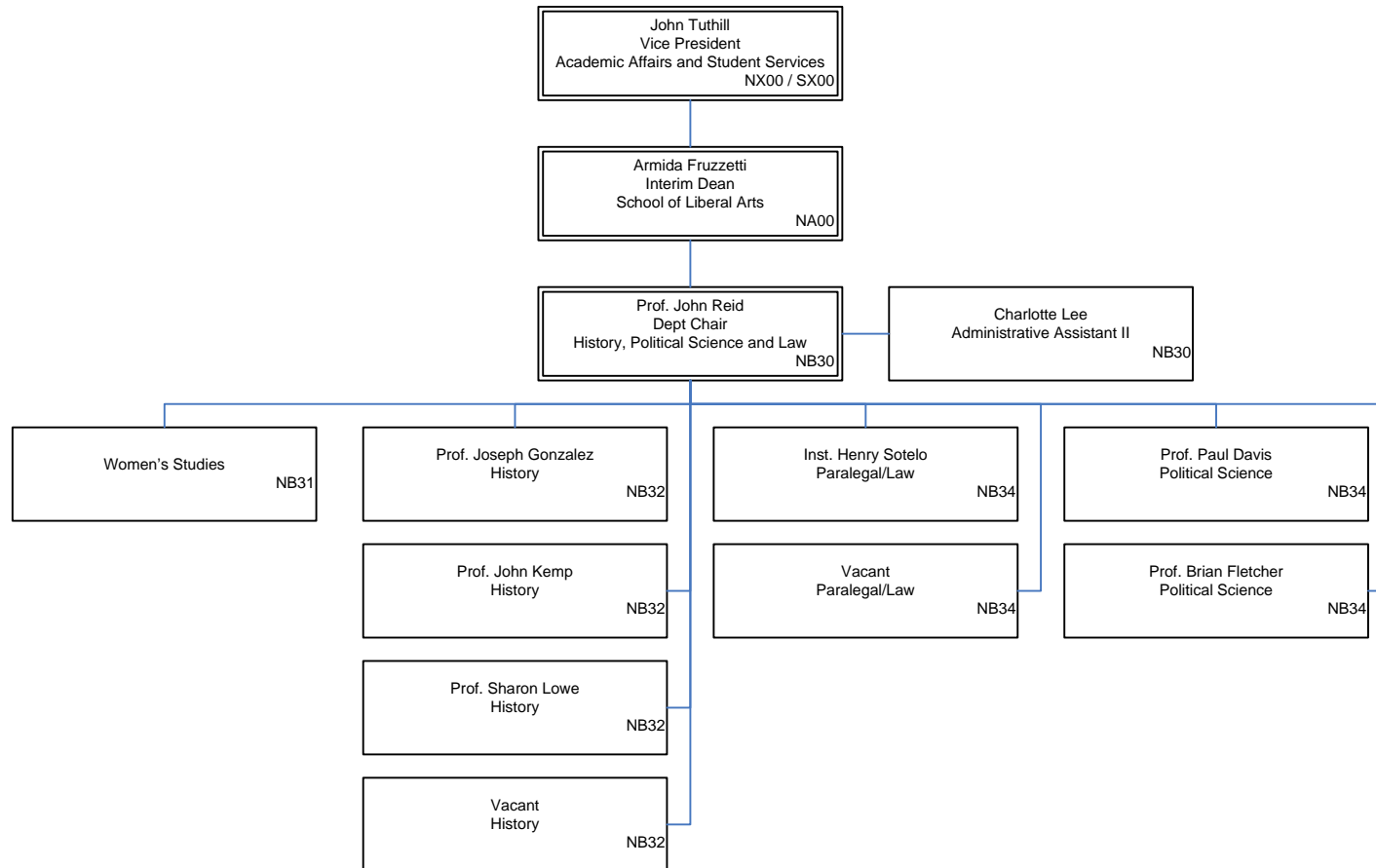

Organizational Chart 9-1-2011

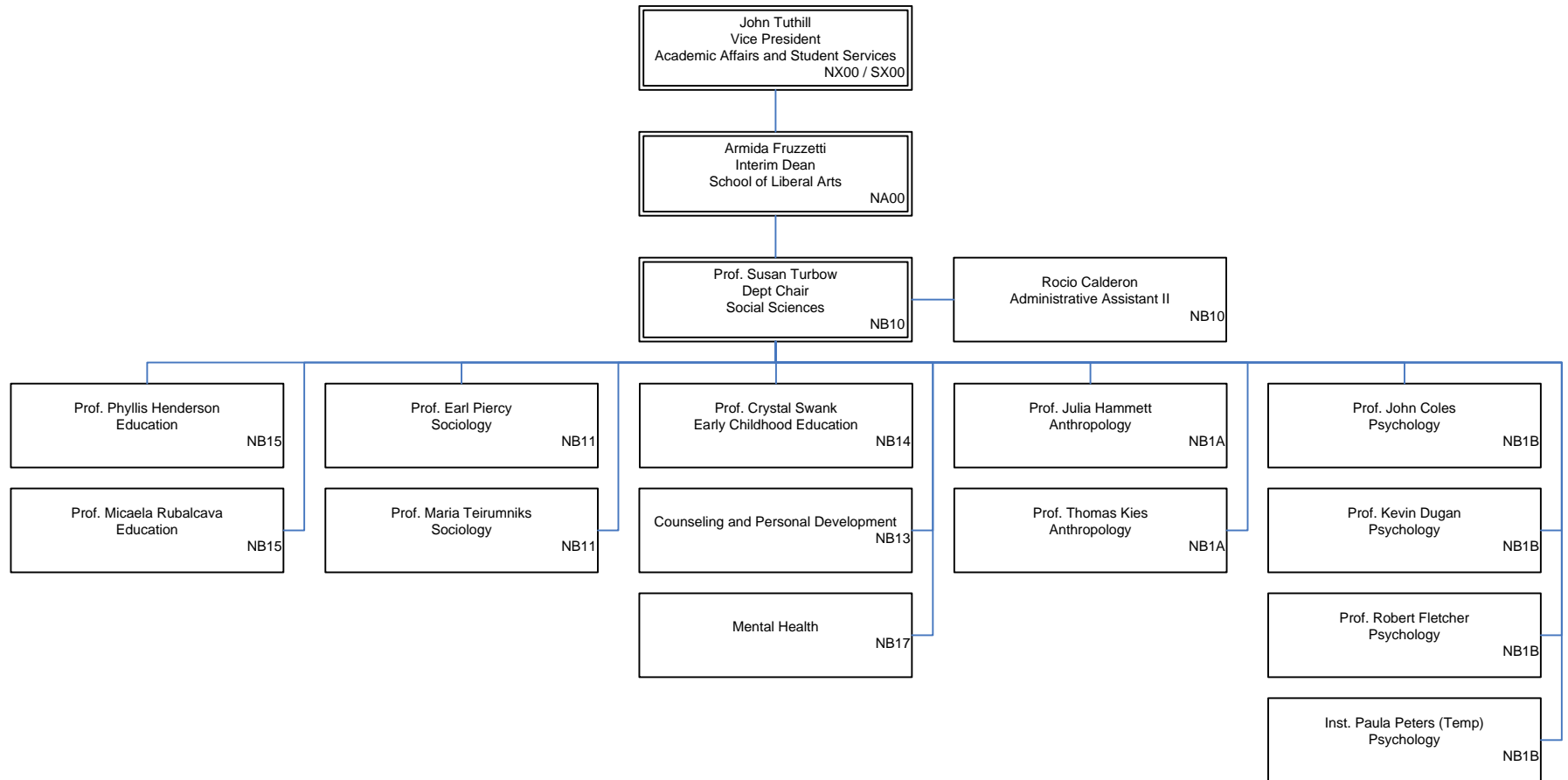

Organizational Chart 9-1-2011

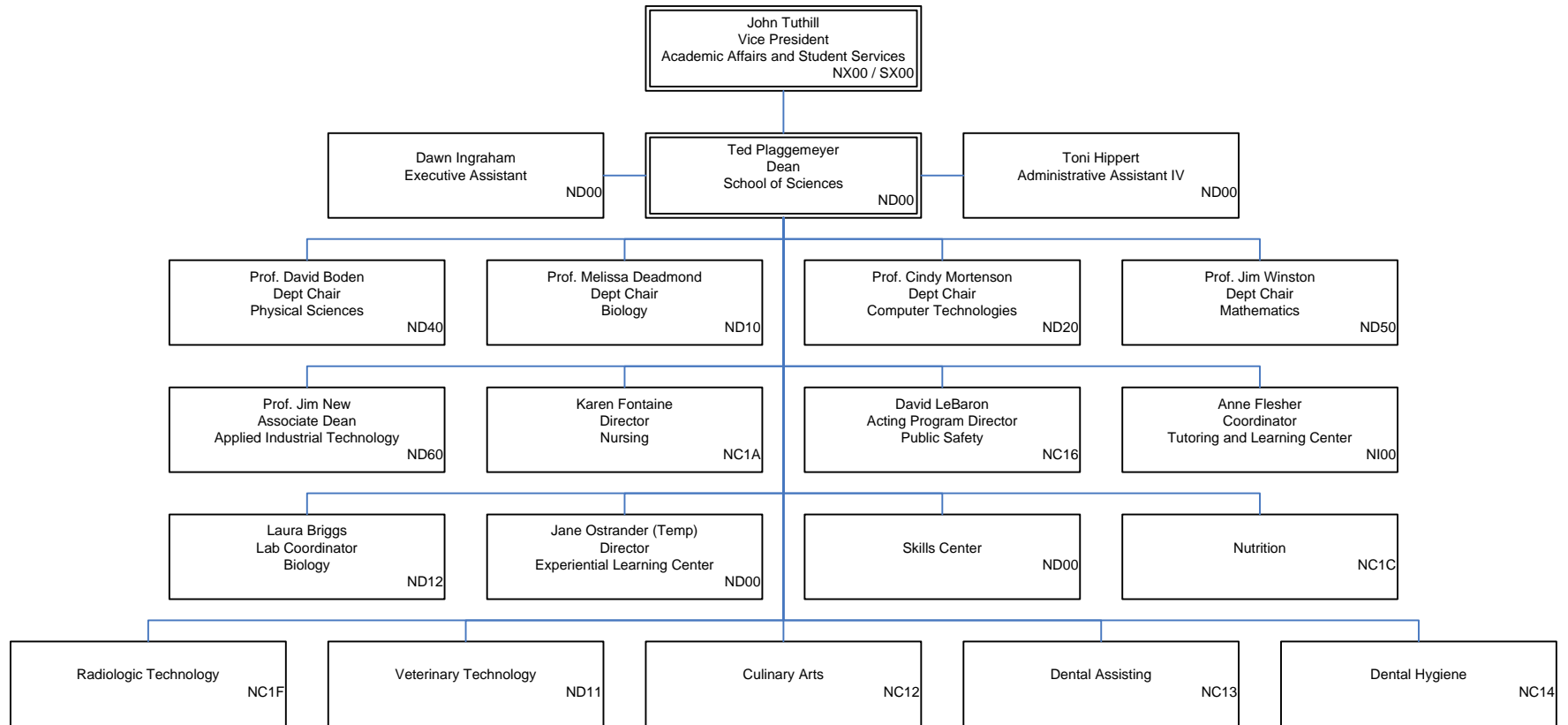

Organizational Chart 9-1-2011

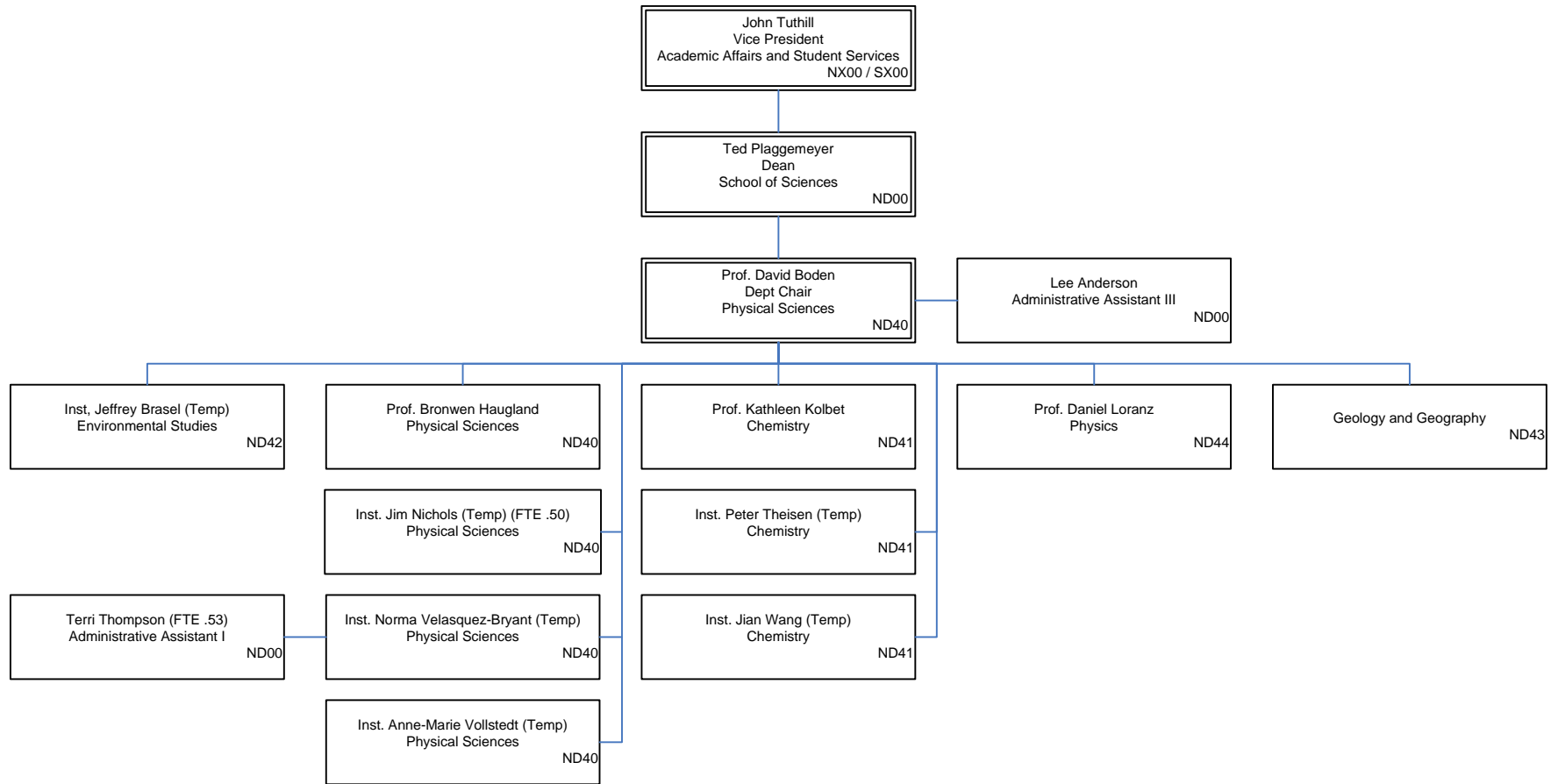

Organizational Chart 9-1-2011

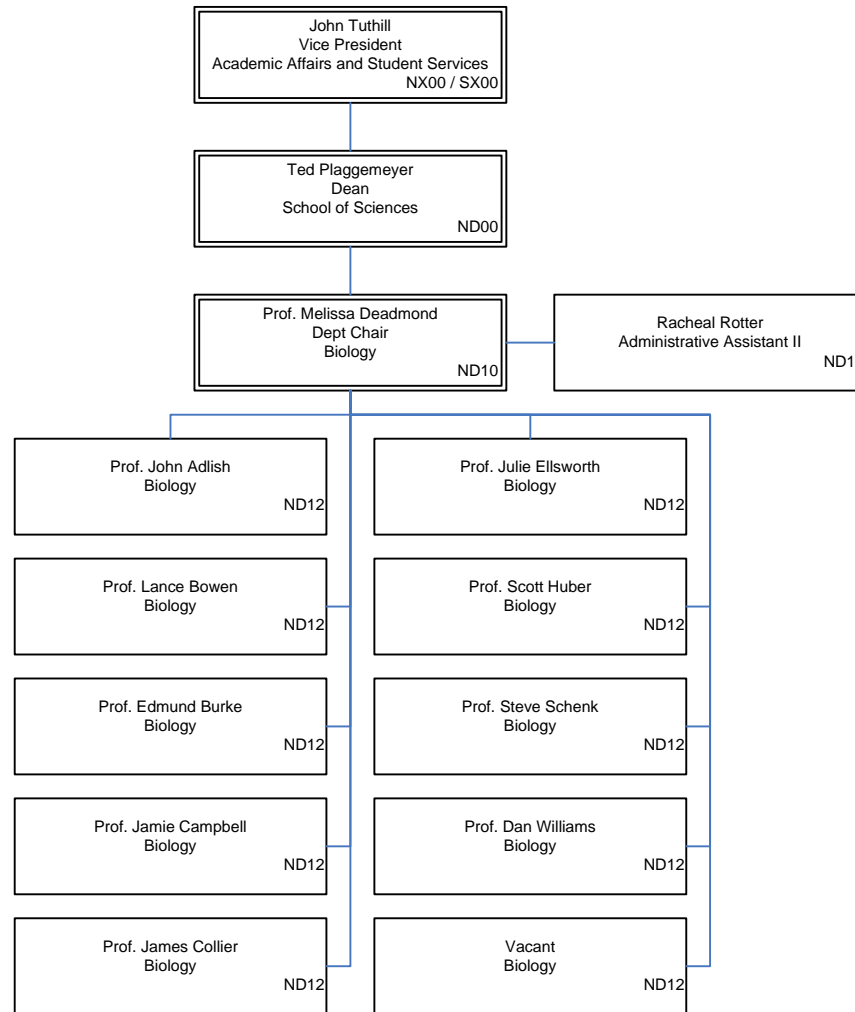

Organizational Chart 9-1-2011

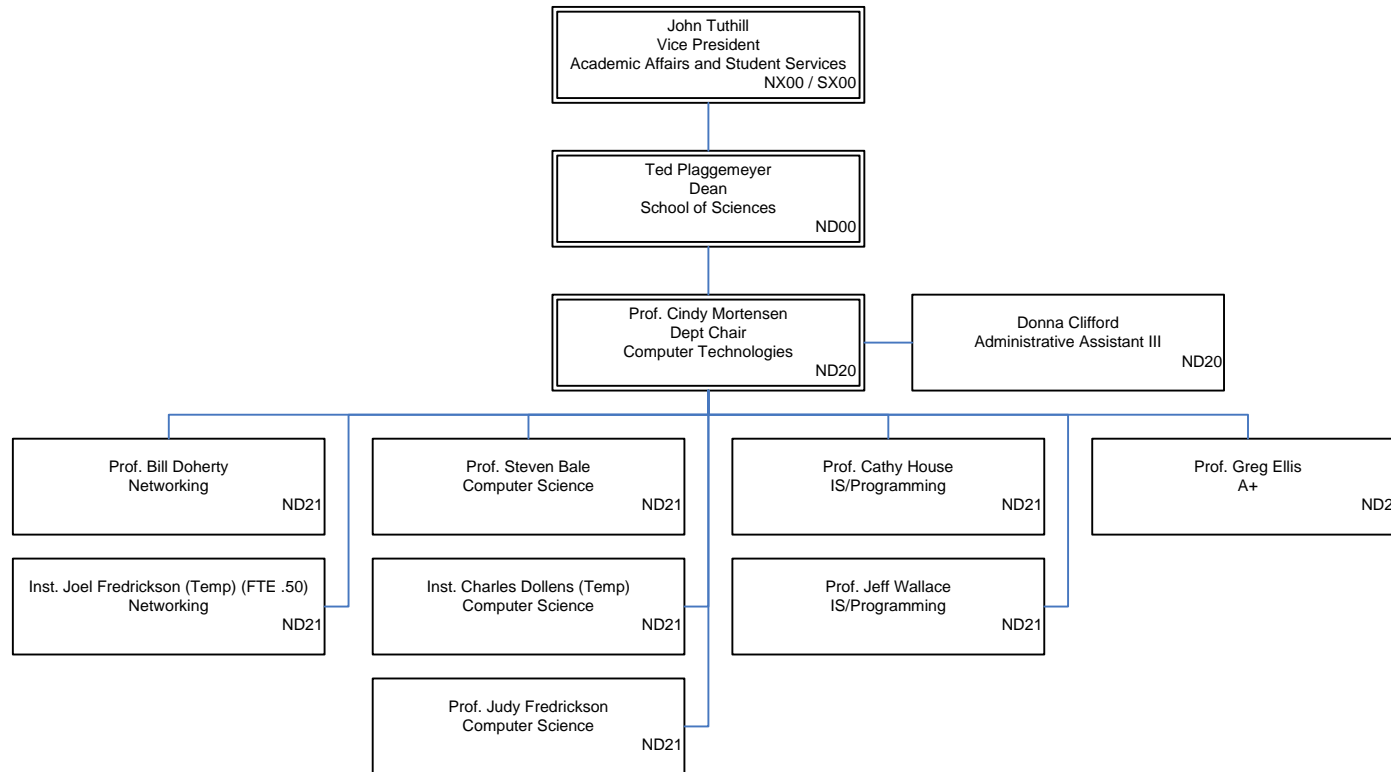

Organizational Chart 9-1-2011

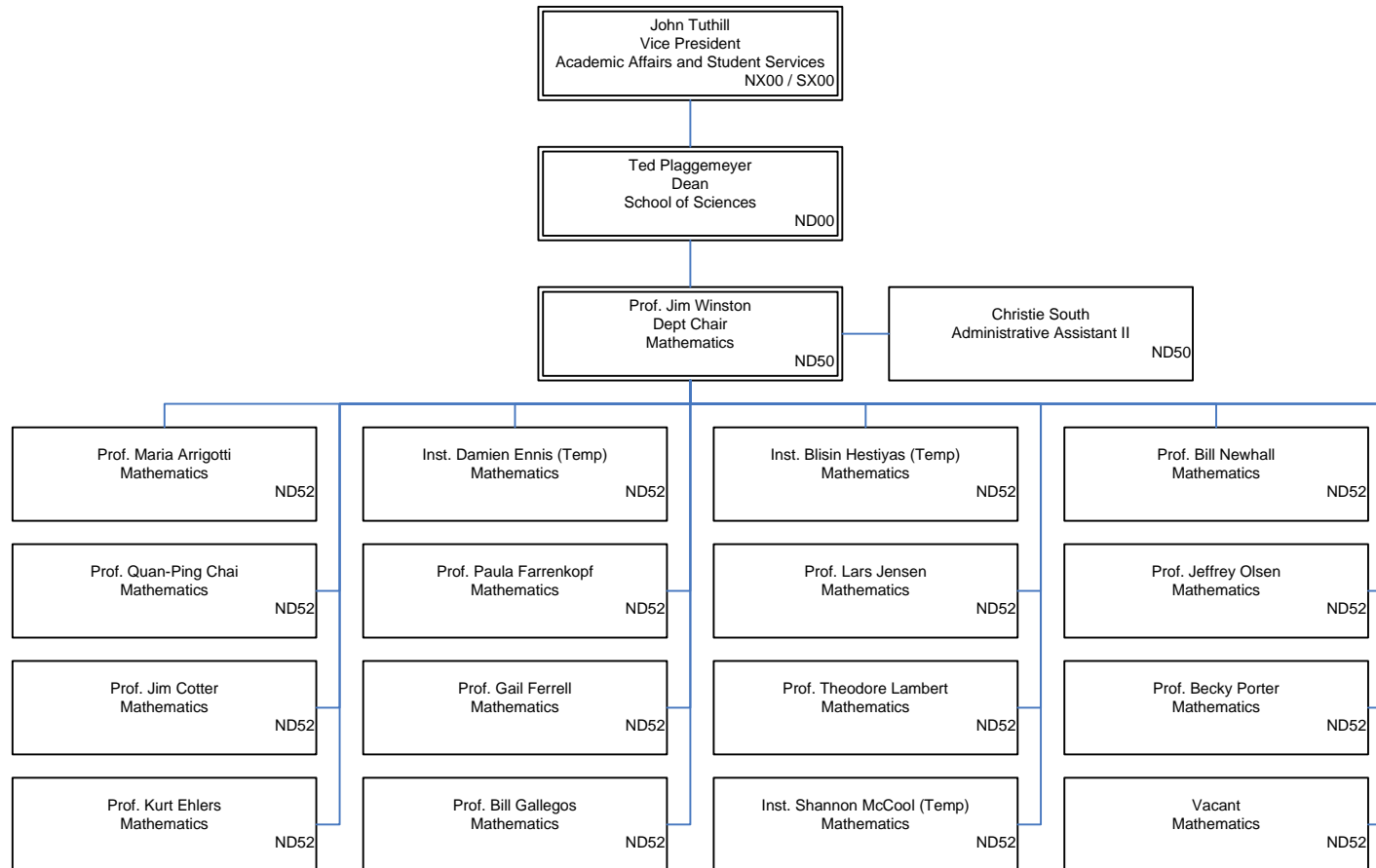

Organizational Chart 9-1-2011

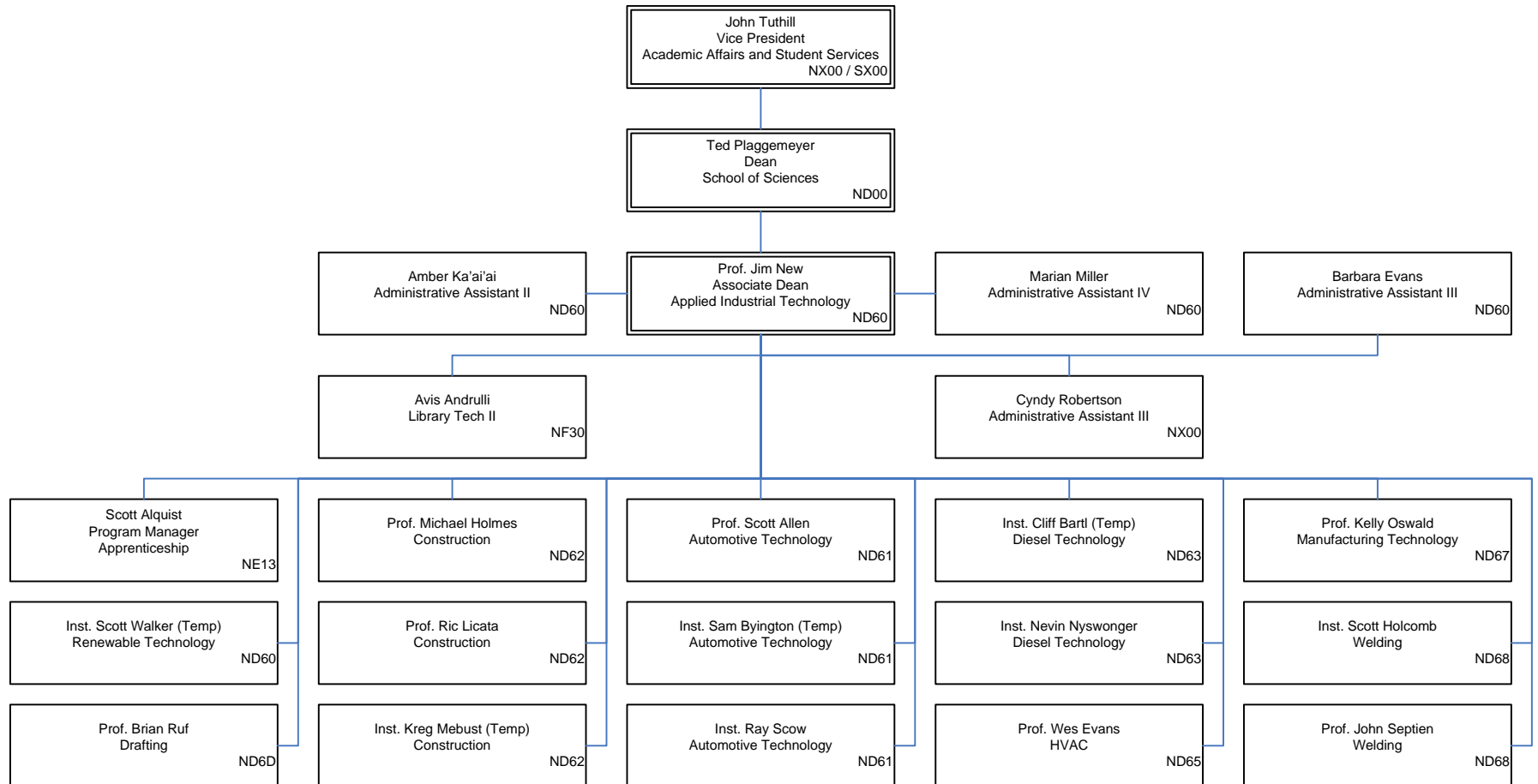

Organizational Chart 9-1-2011

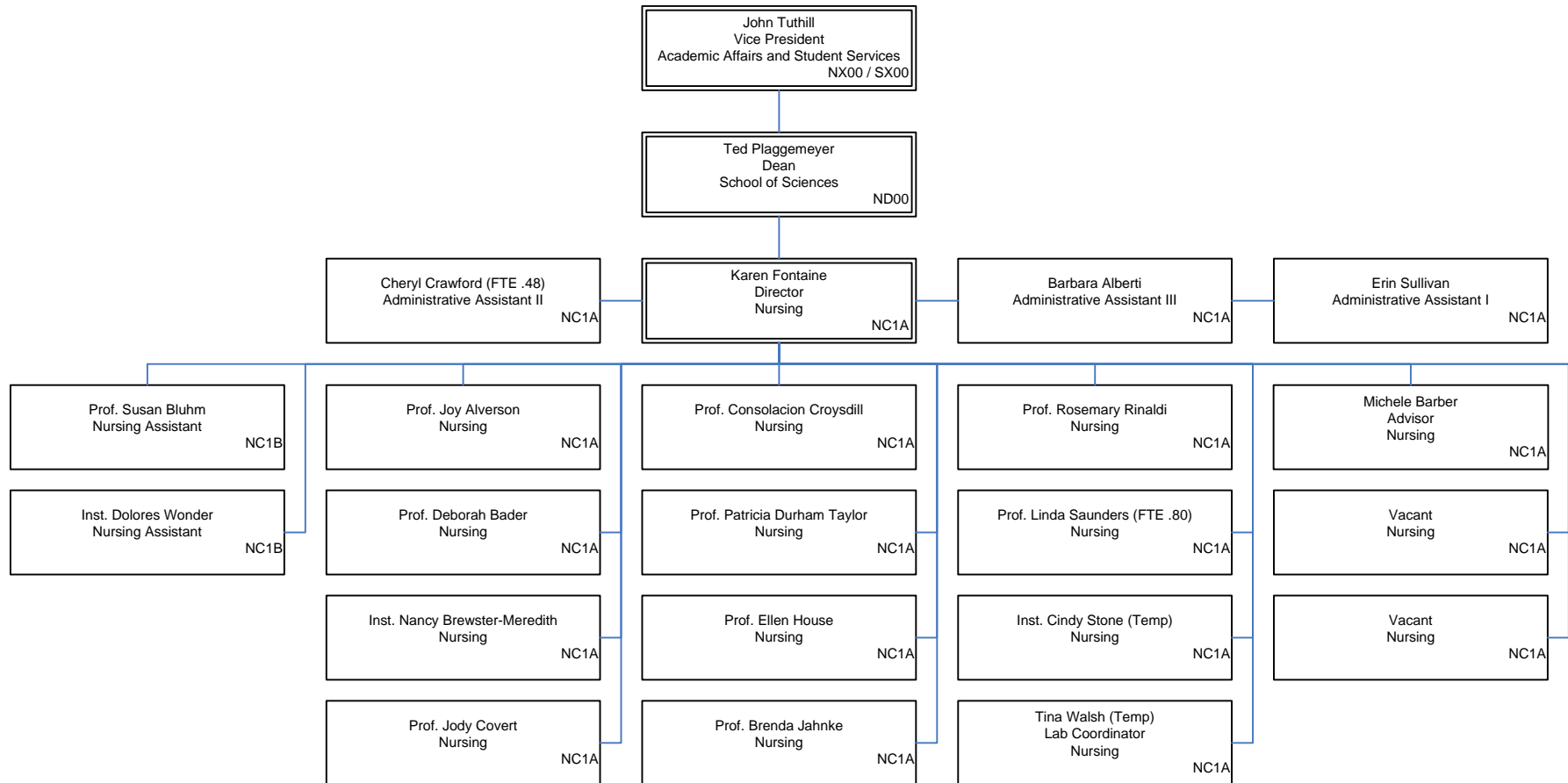

Organizational Chart 9-1-2011

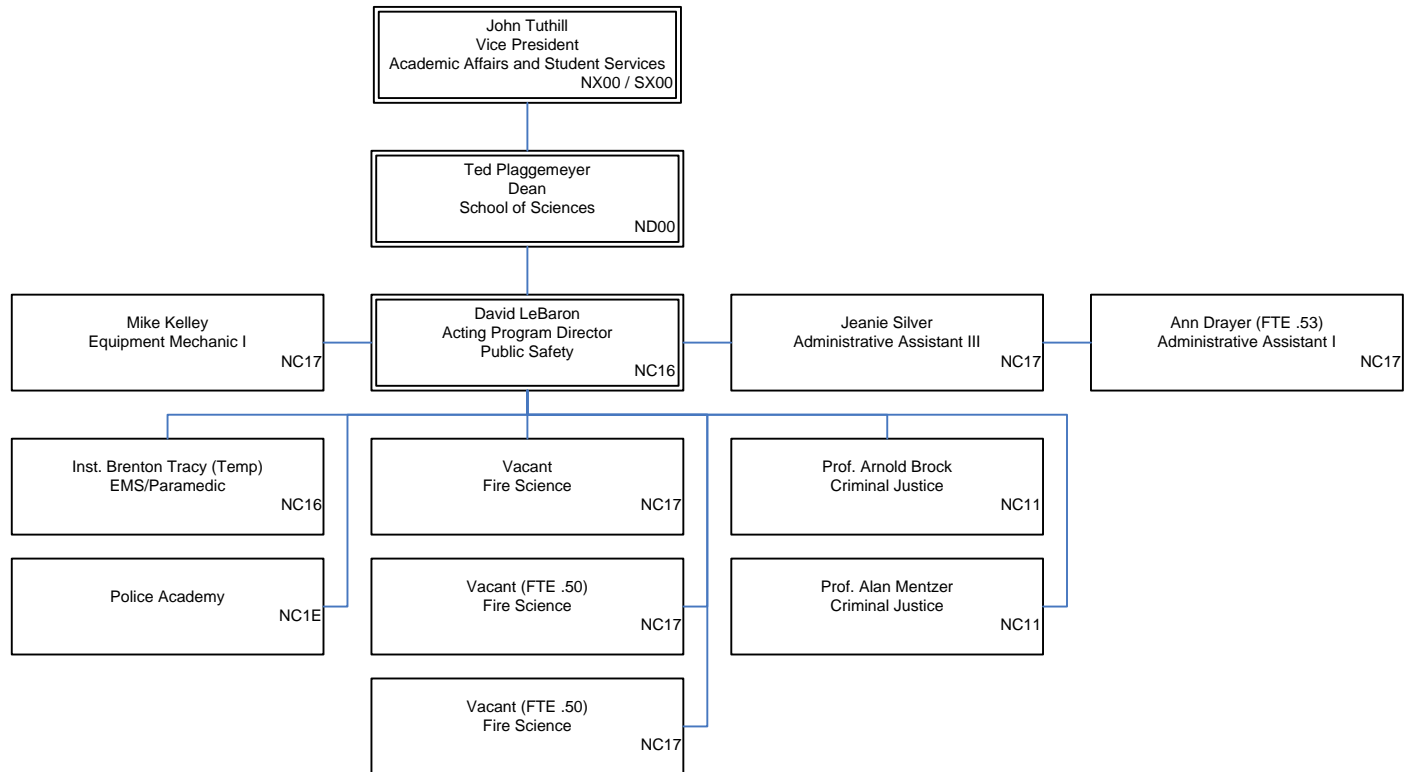

Organizational Chart 9-1-2011

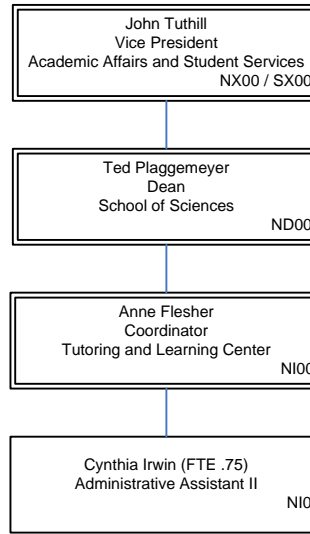

Organizational Chart 9-1-2011

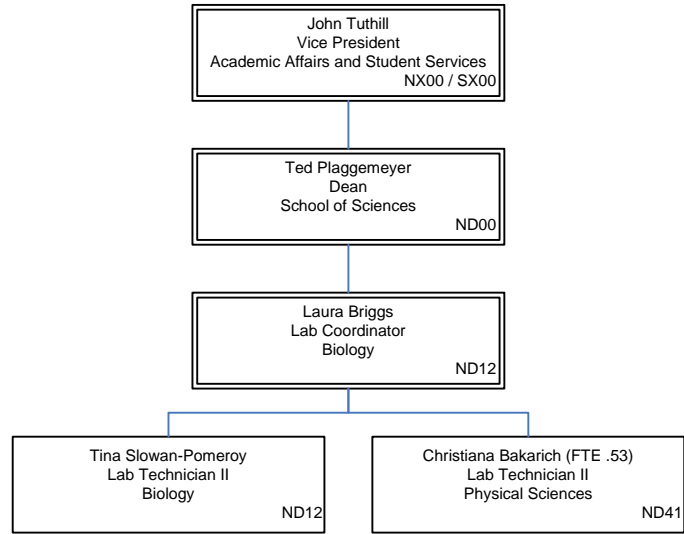

Organizational Chart 9-1-2011

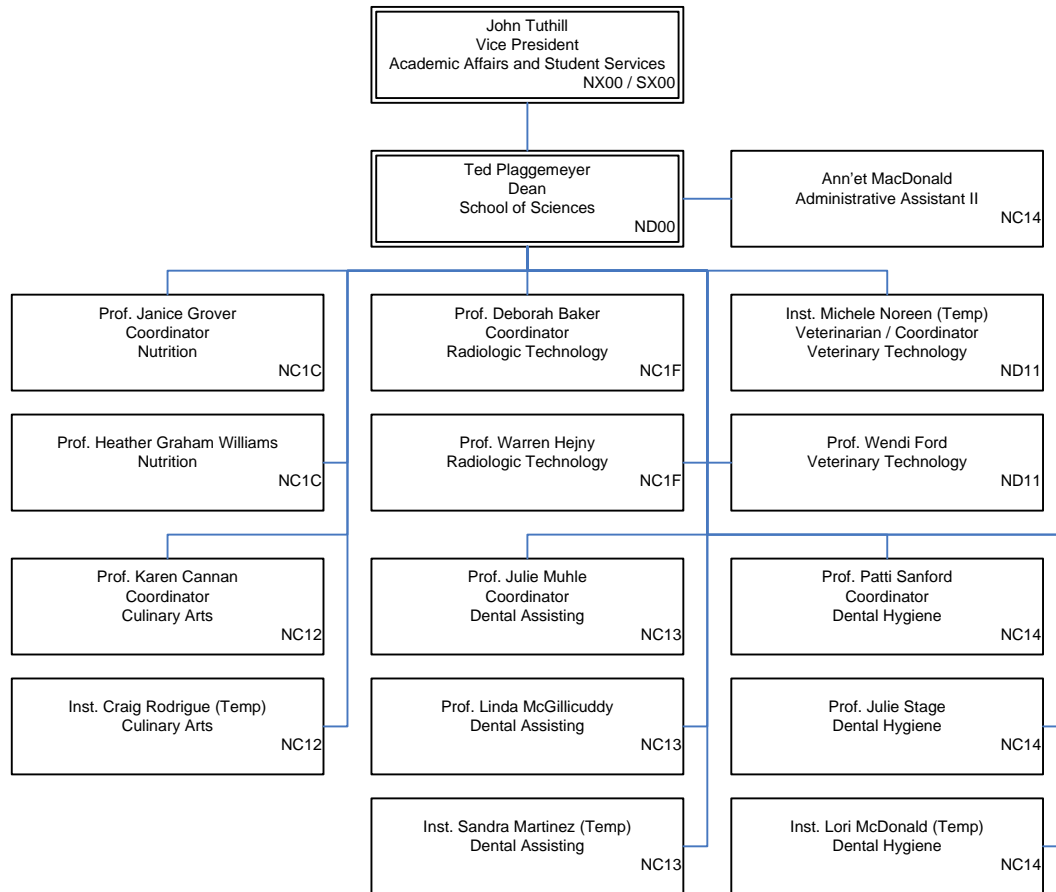

Organizational Chart 9-1-2011

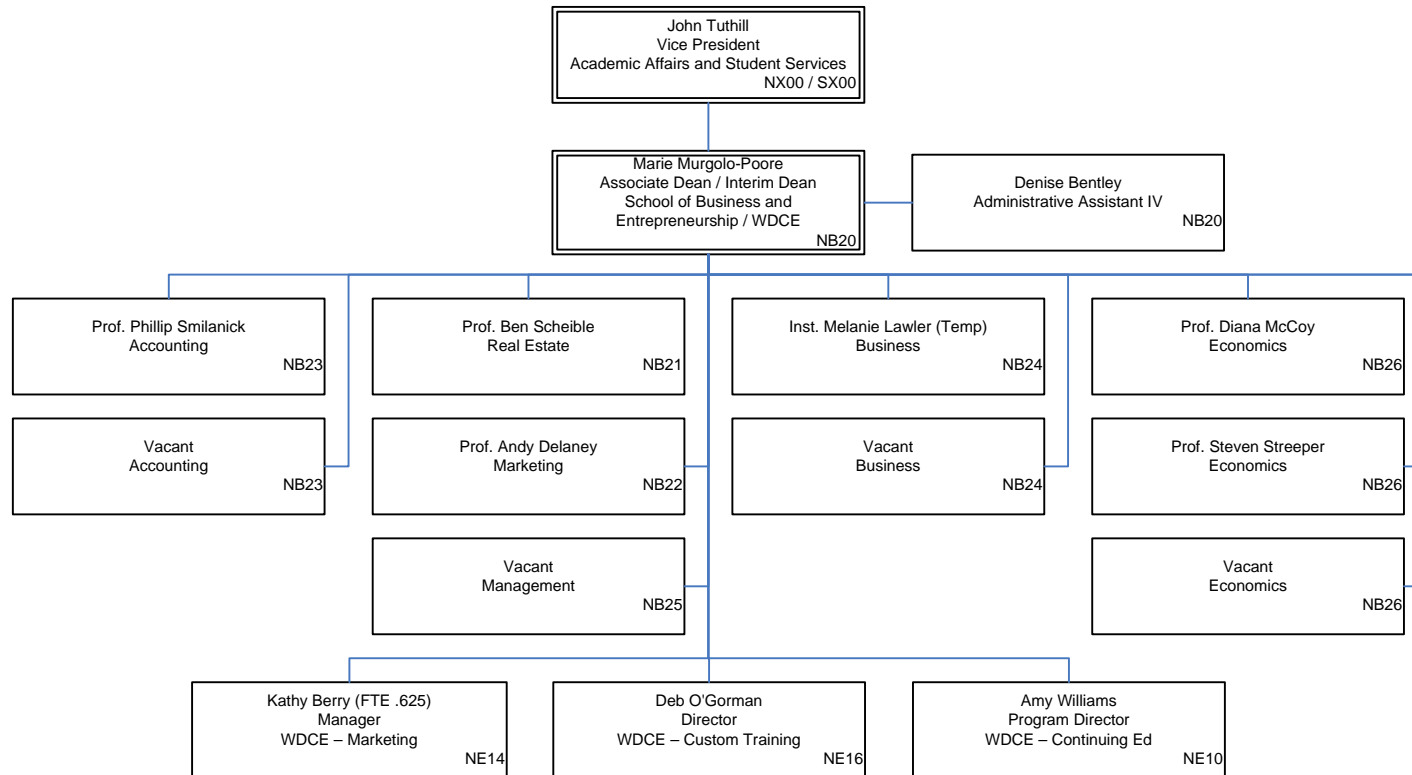

Organizational Chart 9-1-2011

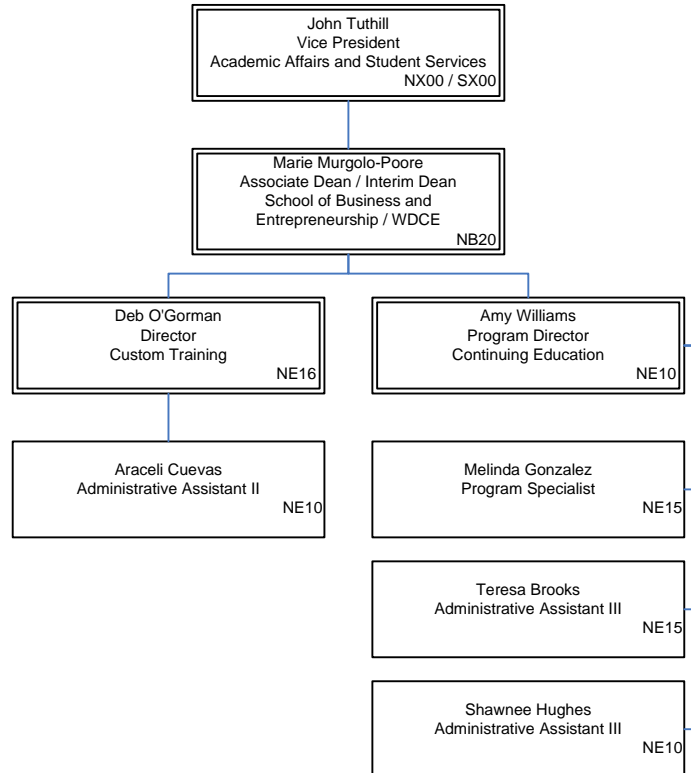

Organizational Chart 9-1-2011

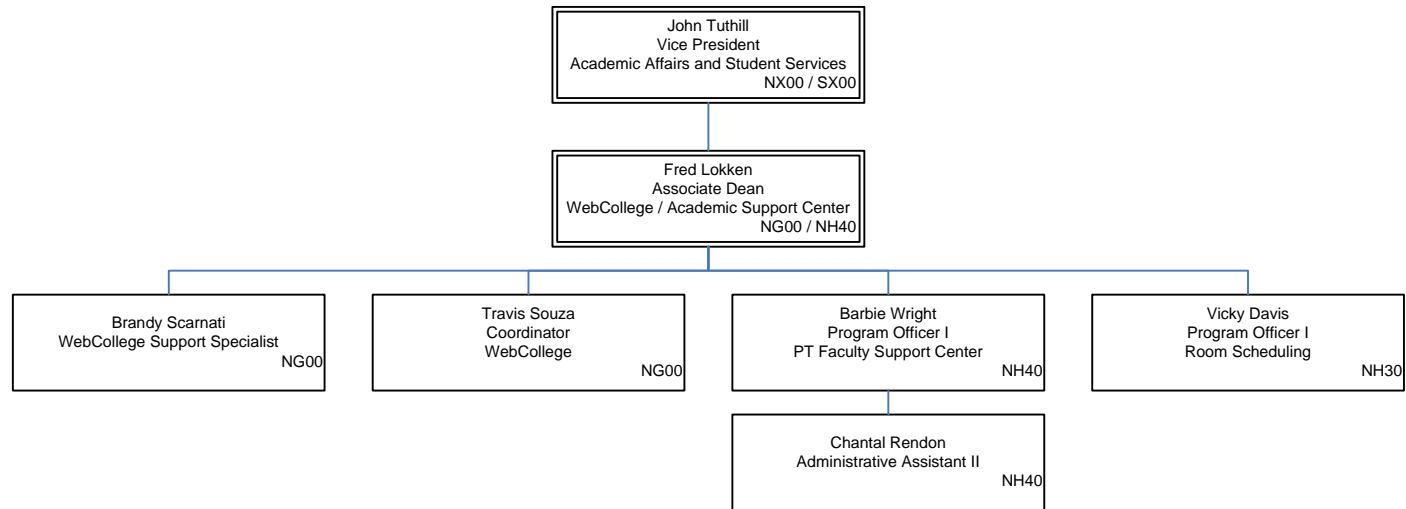

Organizational Chart 9-1-2011

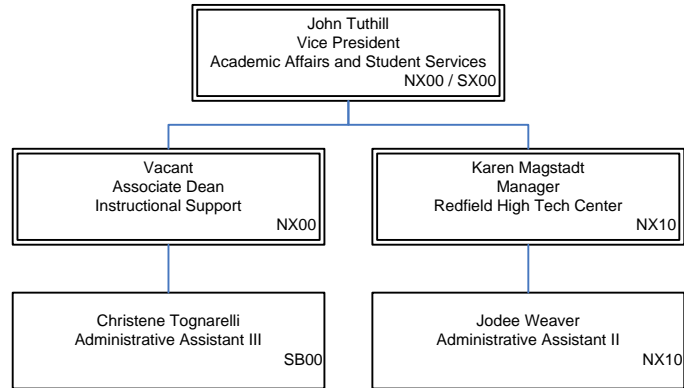

Organizational Chart 9-1-2011

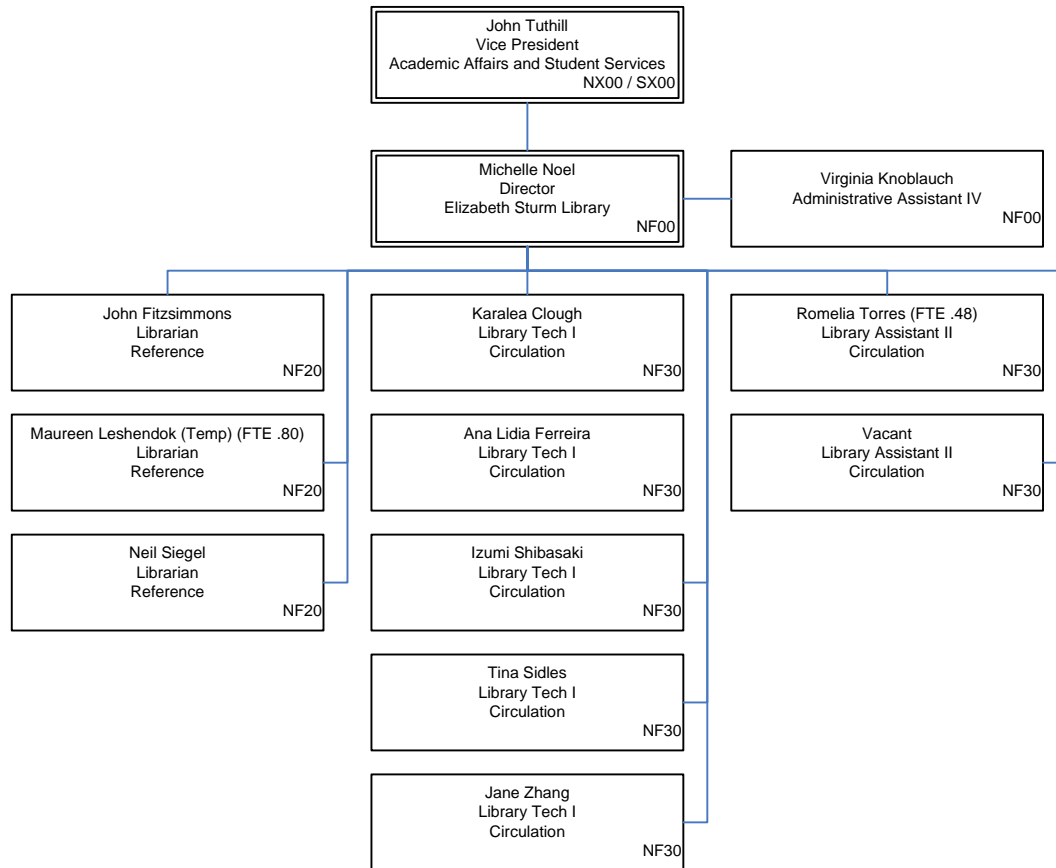

Organizational Chart 9-1-2011

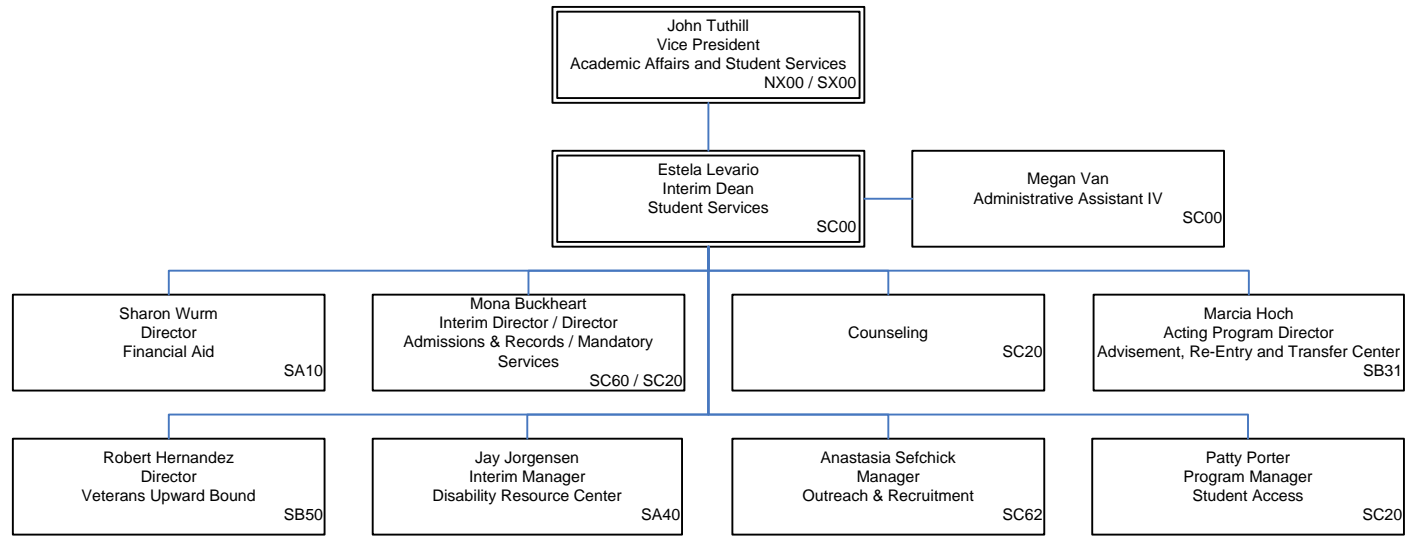

Organizational Chart 9-1-2011

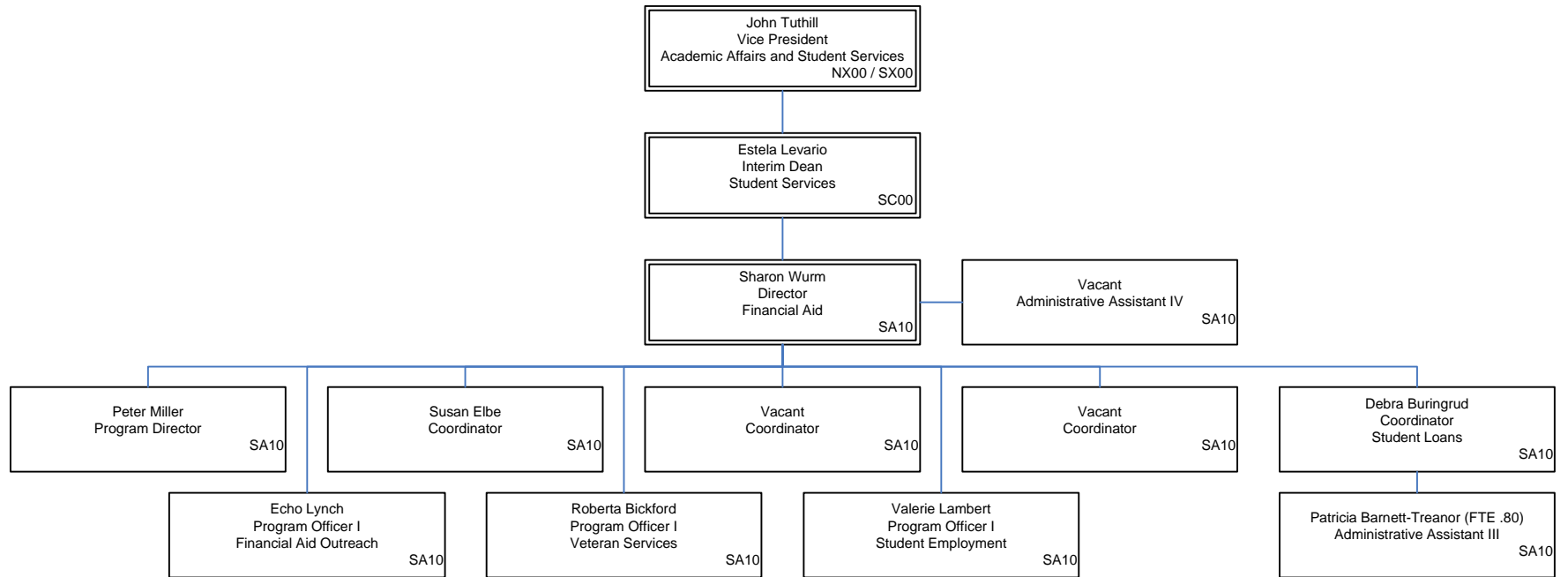

Organizational Chart 9-1-2011

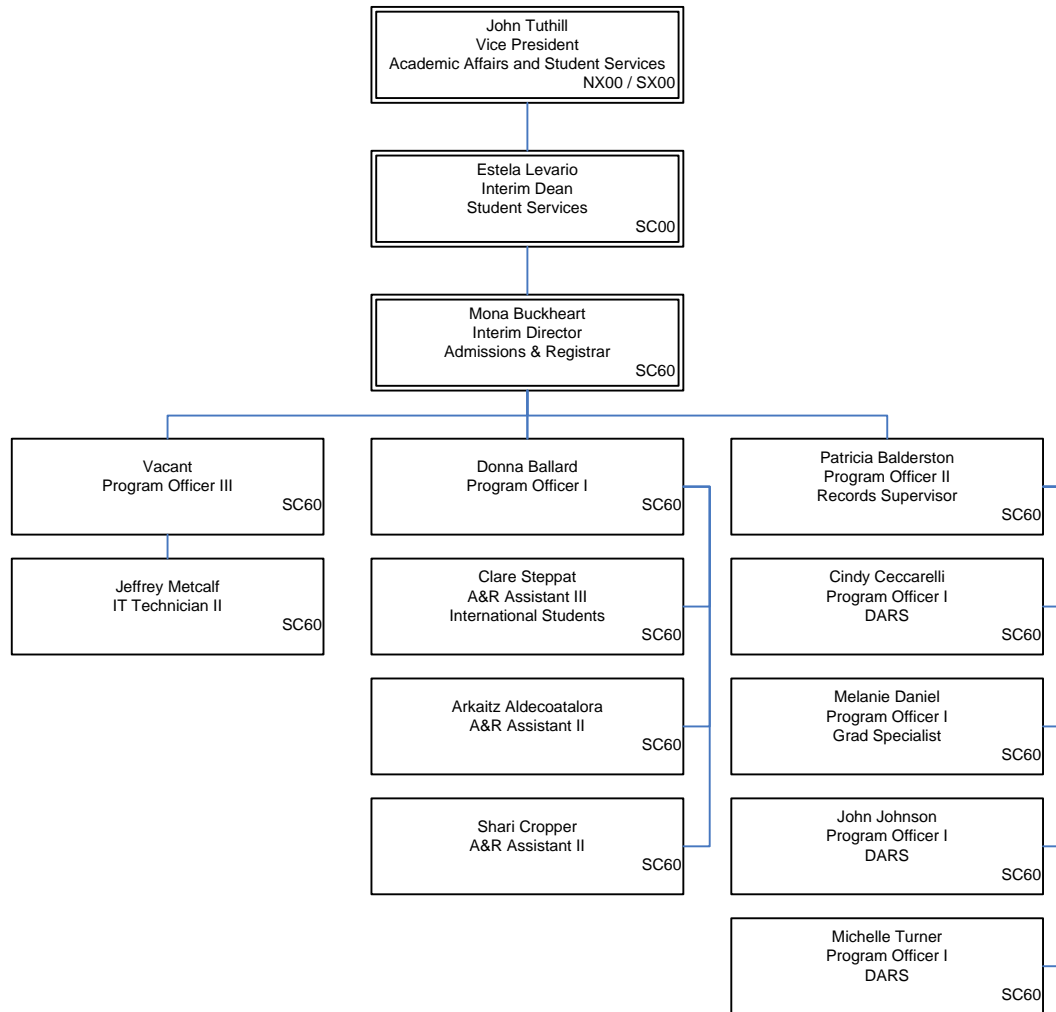

Organizational Chart 9-1-2011

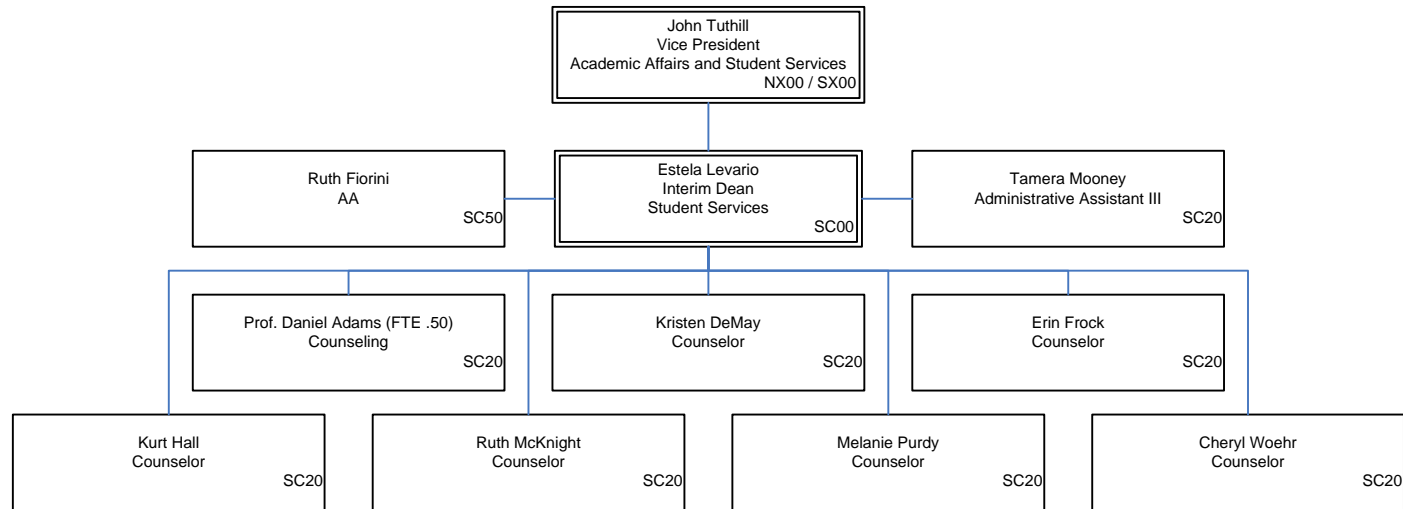

Organizational Chart 9-1-2011

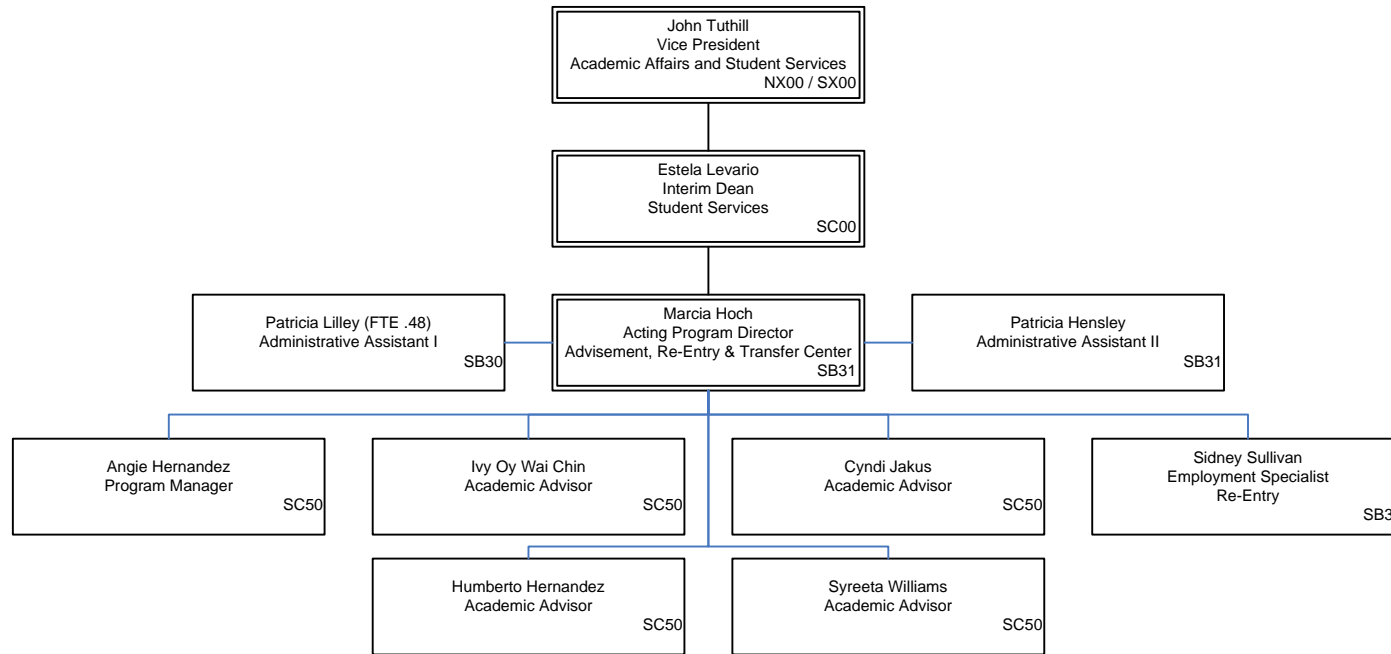

Organizational Chart 9-1-2011

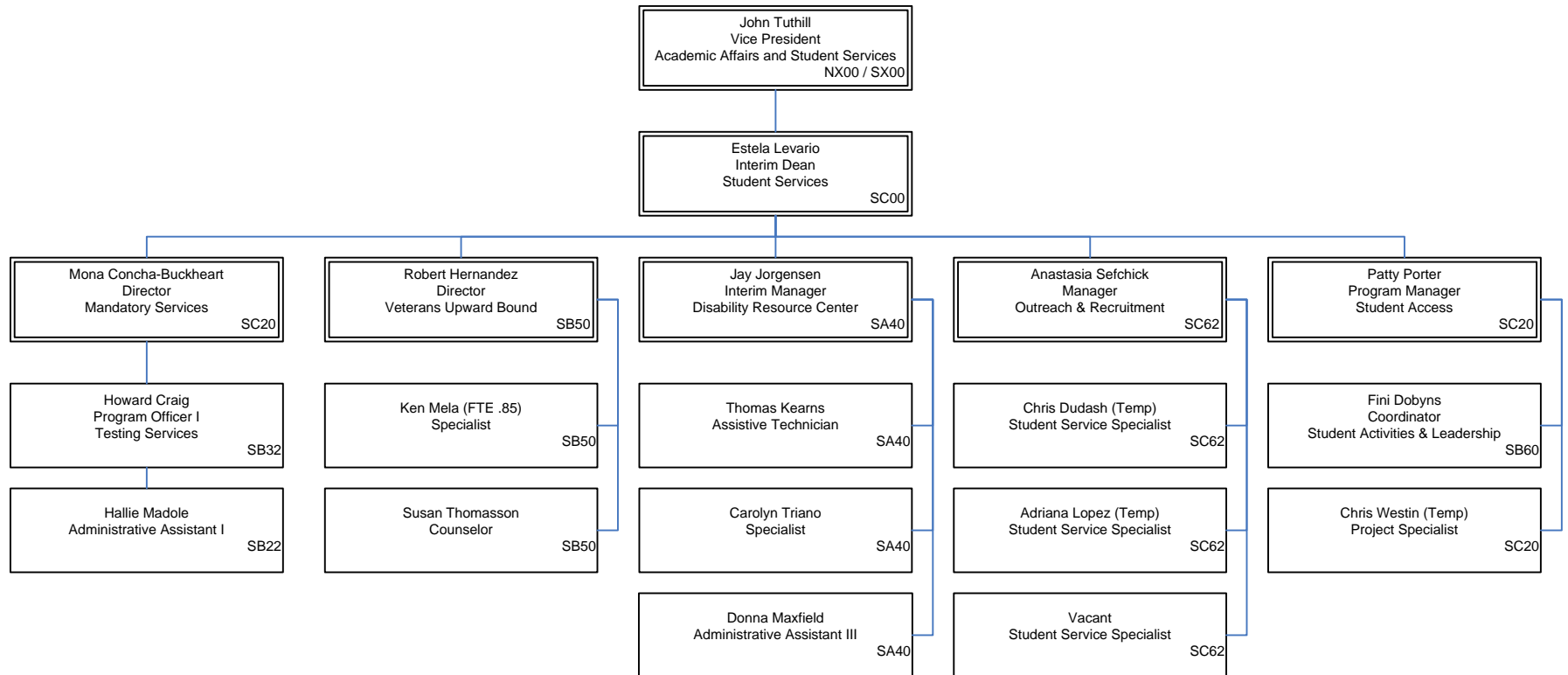

Organizational Chart 9-1-2011

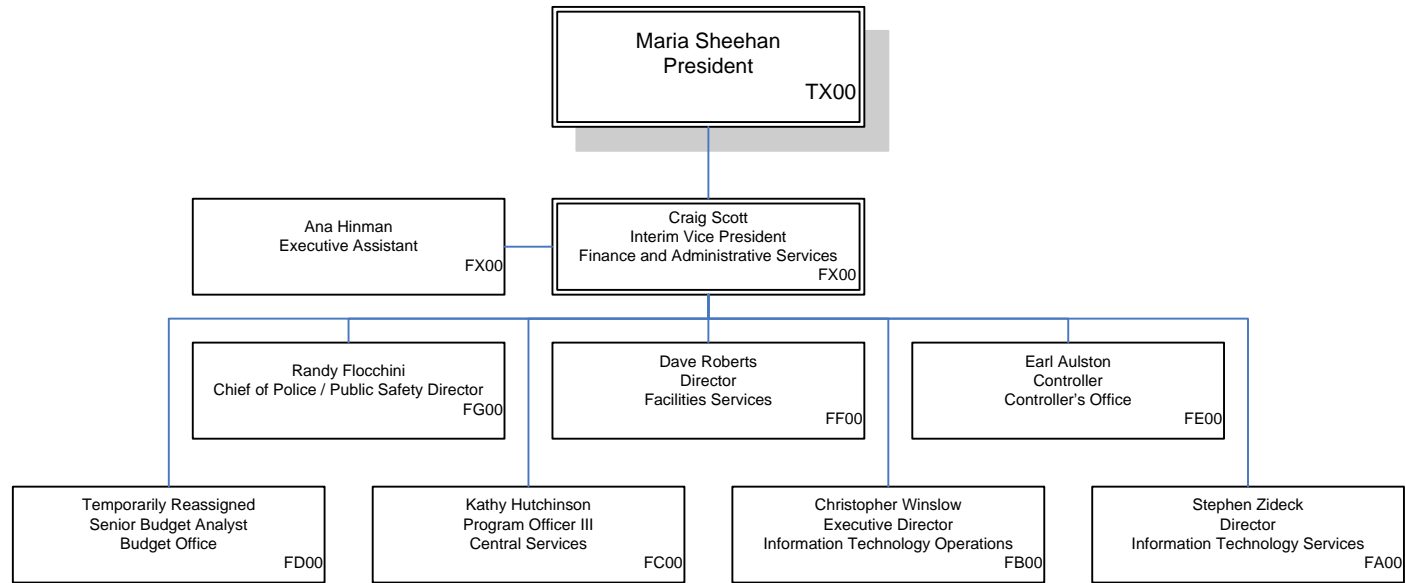

Organizational Chart 9-1-2011

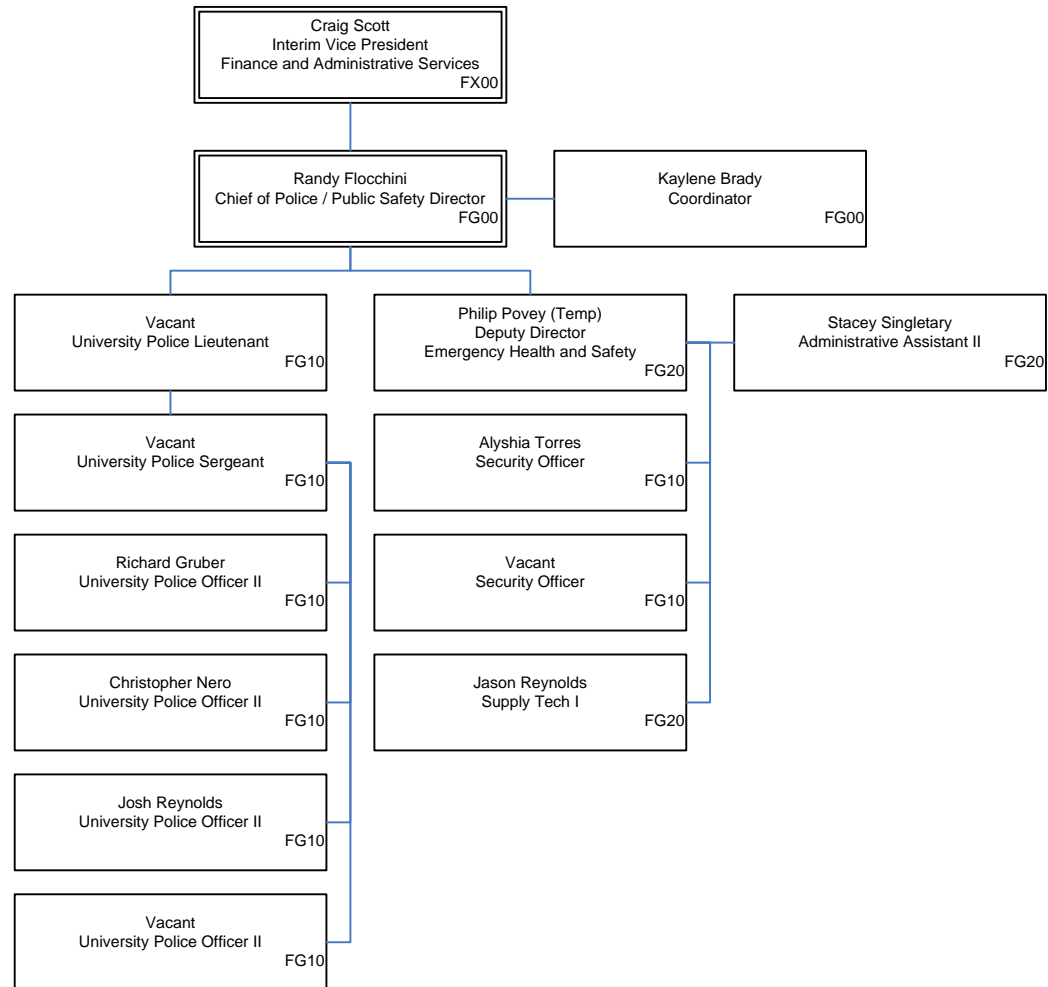

Organizational Chart 9-1-2011

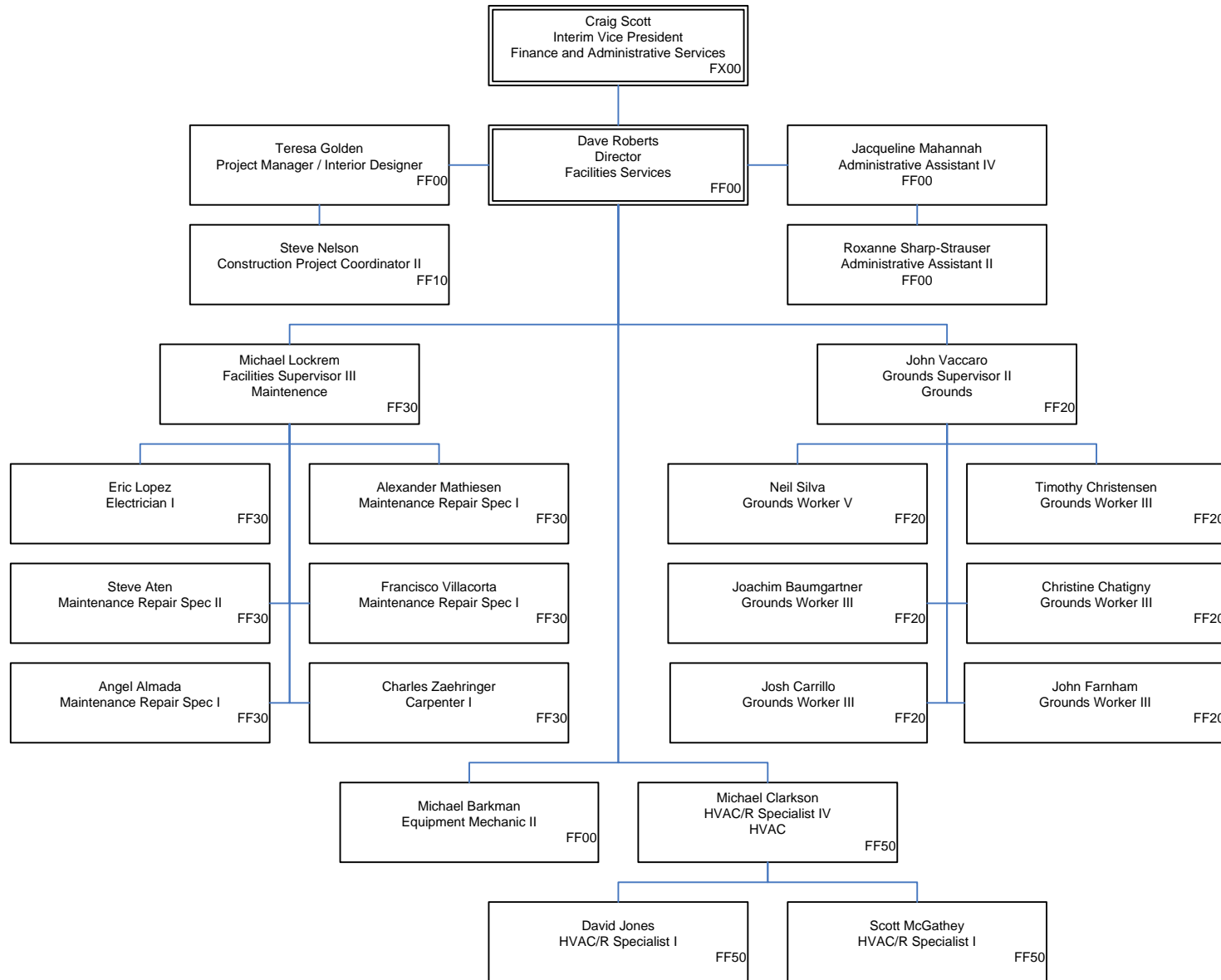

Organizational Chart 9-1-2011

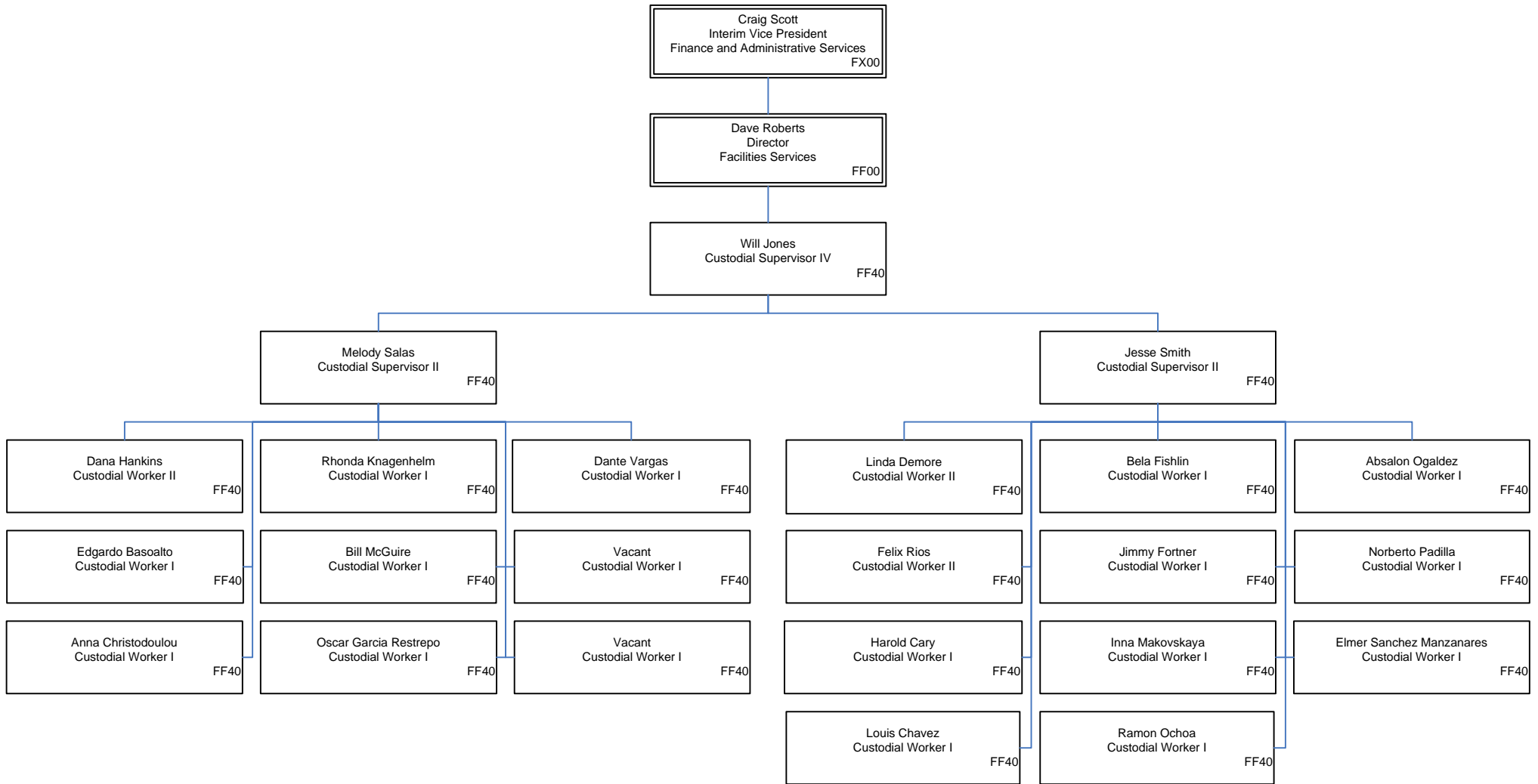

Organizational Chart 9-1-2011

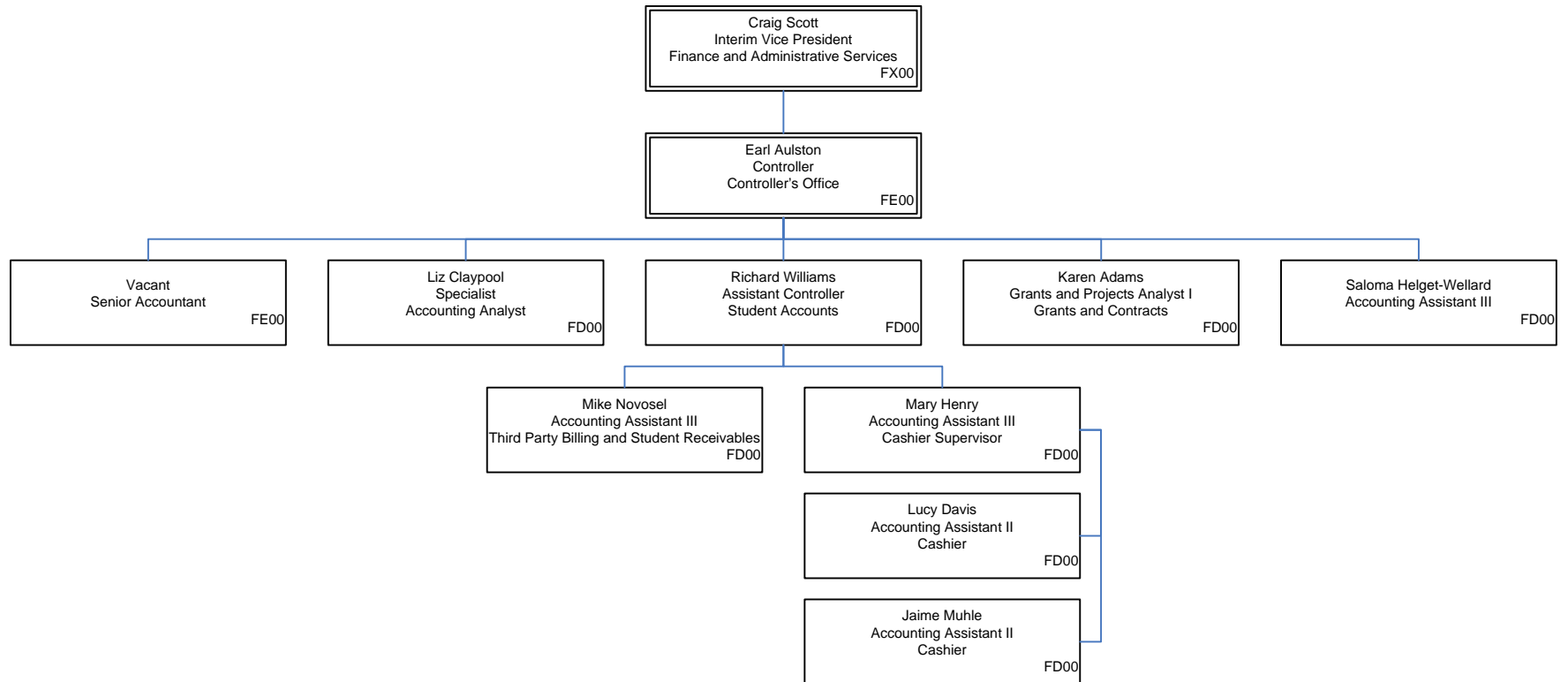

Organizational Chart 9-1-2011

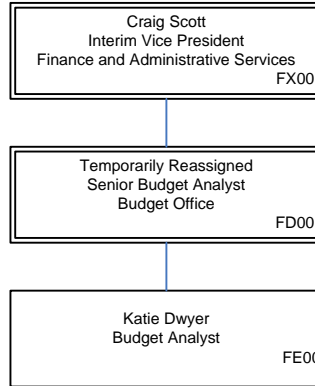

Organizational Chart 9-1-2011

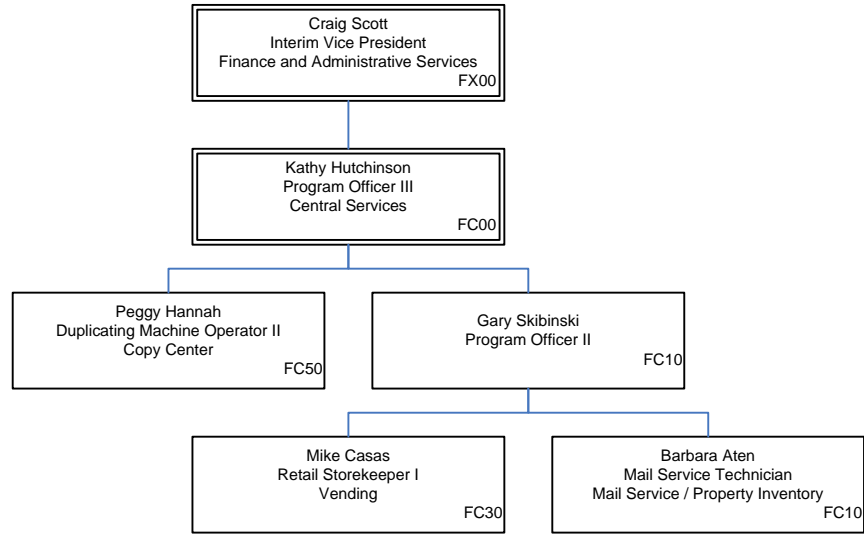

Organizational Chart 9-1-2011

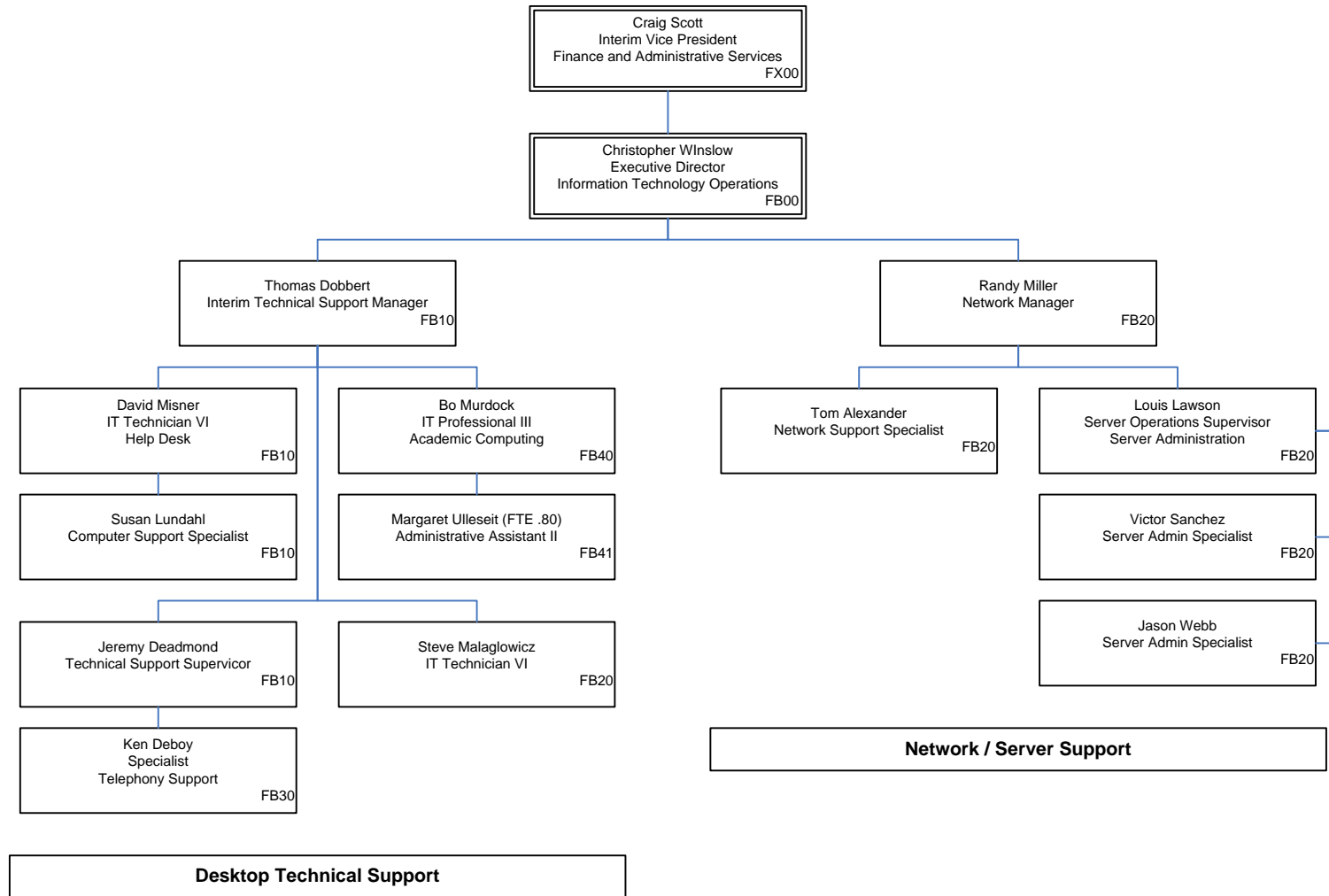

Organizational Chart 9-1-2011

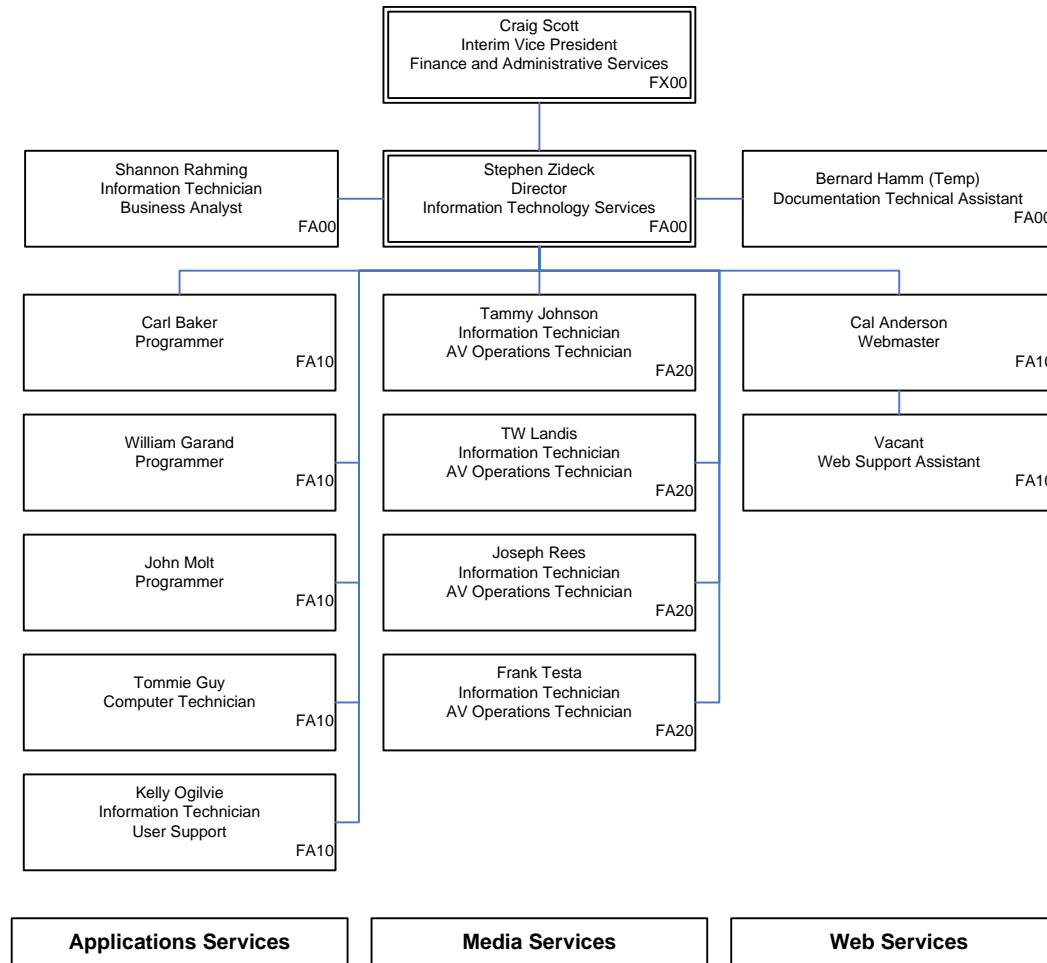

Organizational Chart 9-1-2011

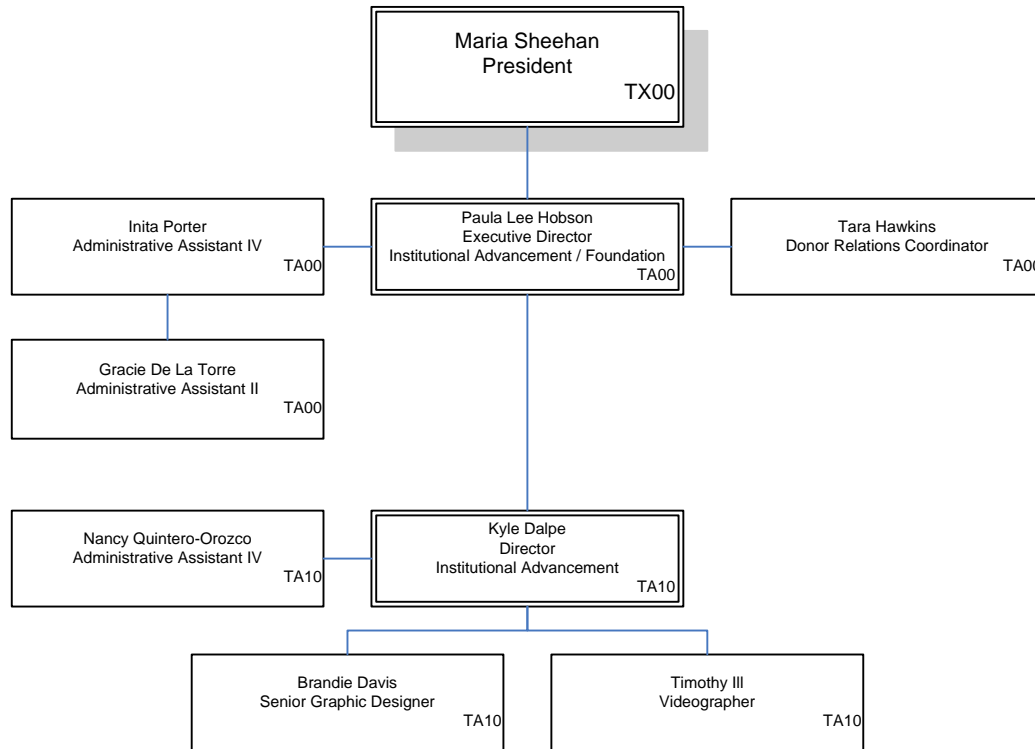

Organizational Chart 9-1-2011

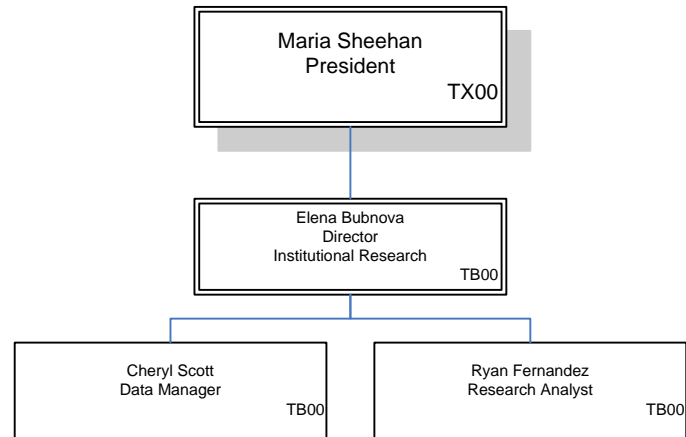

Organizational Chart 9-1-2011

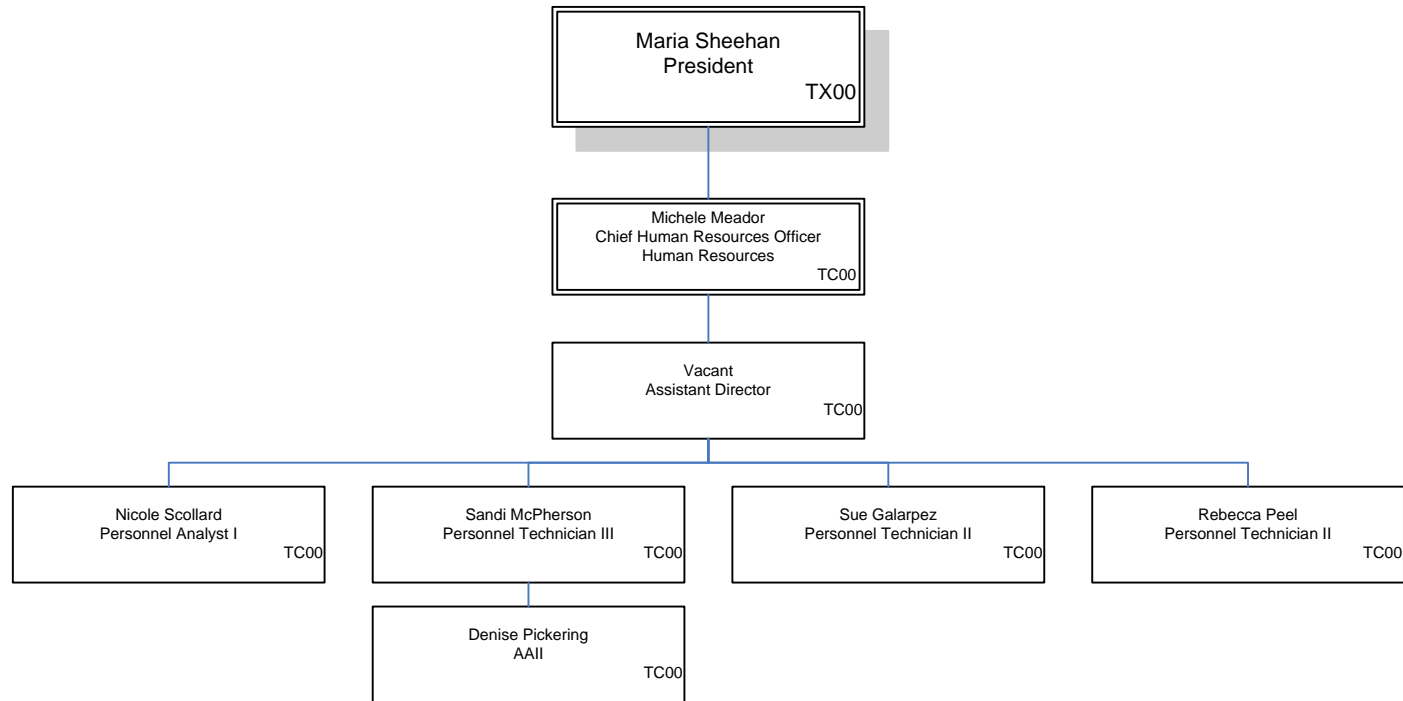

Organizational Chart 9-1-2011

